

F|S

FABRICS-STORE.COM

*Our linen is nothing short of addicting*

# DEVIN PAJAMAS



## LUX LOUNGEWEAR

*Before we get ready to party our way into 2019,  
let's indulge in a little bit of laid-back  
lounging with our linen pajamas!*

Available in Ladies Sizes 0/2 to 28/30

866.620.2008 [ASK@FABRICS-STORE.COM](mailto:ASK@FABRICS-STORE.COM) [FABRICS-STORE.COM](http://FABRICS-STORE.COM)

---

# DEVIN PATTERN

---

*The classic top has a notched collar, button front, long sleeves and single patch pocket. The pants are elasticated at the waist for the most comfortable, flexible fit.*

*Sized for ladies 0/2 to 28/30*

*Simple step-by-step instructions on our blog  
The Thread @ Fabrics-Store.com*

---

MASHA IS WEARING IL019 COBALT FS SIGNATURE FINISH.



Our lovely model Masha is wearing Size 4/6.

# PATTERN DETAILS

#FABRICSTOREDEVINPATTERN



## DEVIN PATTERN

Ladies Duo Sizes: 0/2 to 28/30

- Semi-fitted.
- Button front with lapel and collar.
- Chest pocket
- Elastic waist pant

## SEWING INSTRUCTIONS

This pattern is featured on our blog "The Thread" at [Fabrics-Store.com](http://Fabrics-Store.com). There you will find step-by-step photo instructions and can ask questions, post comments, or share your progress. Simply visit: [blog.fabrics-store.com](http://blog.fabrics-store.com) and enter "Devin Pattern" in the search box.

## SIZING & YARDAGE

Ladies Size Guide Based on Body Measurements in Inches

Size	0/2	4/6	8/10	12/14	16/18	20/22	24/26	28/30
Bust	33-34	35-36	37-38	39-40	42-44	46-48	50-52	54-56
Waist	25-26	27-28	29-30	31-32	34-36	38-40	42-44	46-48
Hip	35-36	37-38	39-40	41-42	44-46	48-50	52-54	56-58

Finished Garment Measurements - Approximate in Inches

Size	0/2	4/6	8/10	12/14	16/18	20/22	24/26	28/30
Bust	37.75	39.75	42.25	44.75	48.75	52.75	57.25	61.75
Waist	27	29	31.5	34	38	42	46.5	51
Hips	36.5	38.5	41	43.5	47.5	51.5	56	60.5

Estimated Yardage - 54" Width Linen\*

Size	0/2	4/6	8/10	12/14	16/18	20/22	24/26	28/30
Yardage*	4 yards				5 yards			

\*Allow up to 10% extra fabric for shrinkage

ALL SEAM ALLOWANCES ARE INCLUDED AND NOTED ON THE PATTERN AND IN THE TUTORIAL.

## “Devin” Sewing Pattern

For instructions visit: [blog.fabrics-store.com](http://blog.fabrics-store.com) and enter “Devin Pattern” in the search box.

2 Inch  
Square to  
Check Print  
Accuracy

**PRINT ONLY THIS PAGE FIRST TO CHECK SCALE**

IMPORTANT! PRINT AT ACTUAL SIZE OR 100% SCALE

*Formatted for paper sizes A4 and Letter.*

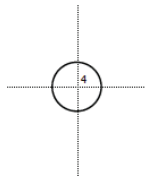

Simply overlap the page margins and align the markings in each corner to complete the circle and tape in place.

**Layered PDF:**  
This pattern has embedded layers so you can print all sizes or a single size. See your .pdf viewers 'Layers' menu.



All Seam Allowances Included

Main seams: 3/8"  
Pant waist: 1.75"  
Sleeve Hem: 1"  
Pant Hem: 1.5"

For instructions visit: [blog.fabrics-store.com](http://blog.fabrics-store.com) and enter “Devin Pattern” in the search box.

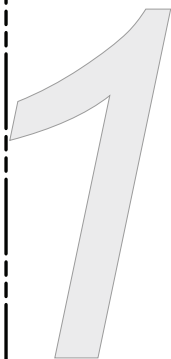

1

**F**  
FABRICS-S

*Our linen is nothing*

**S**  
STORE.COM  
*short of addicting*

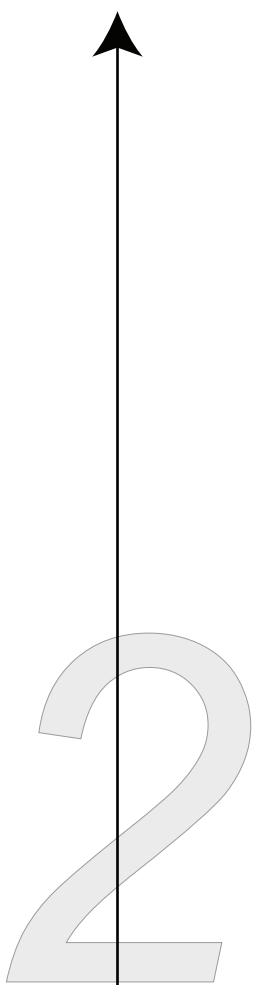

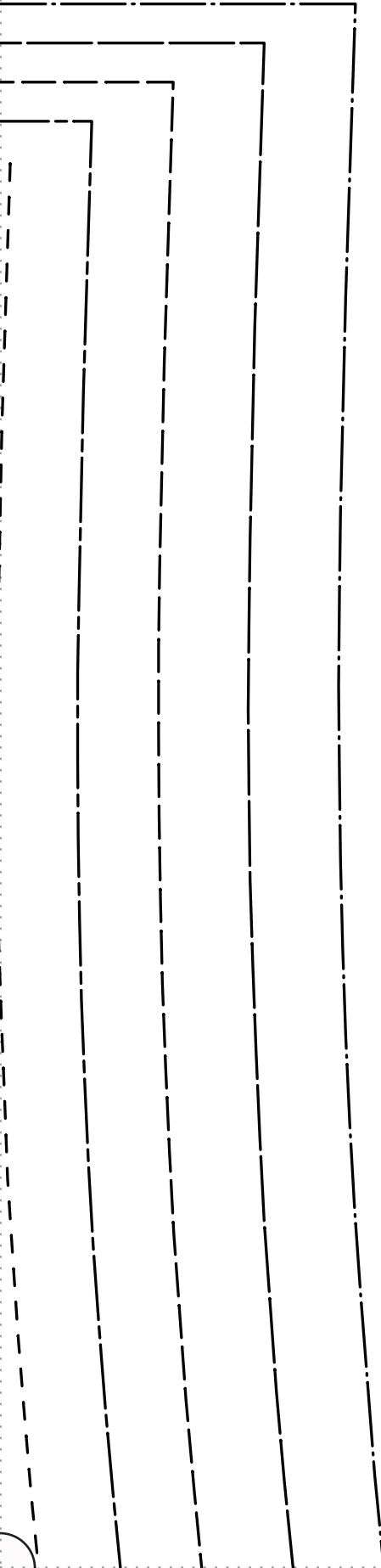

3

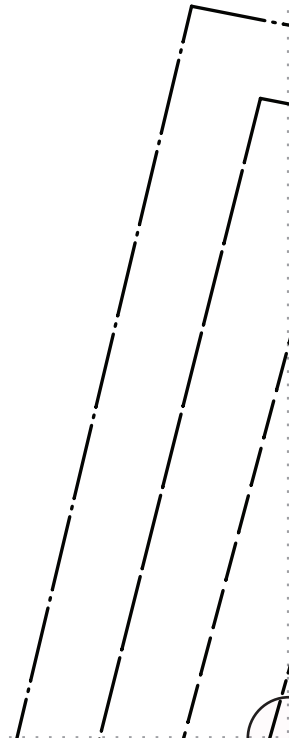



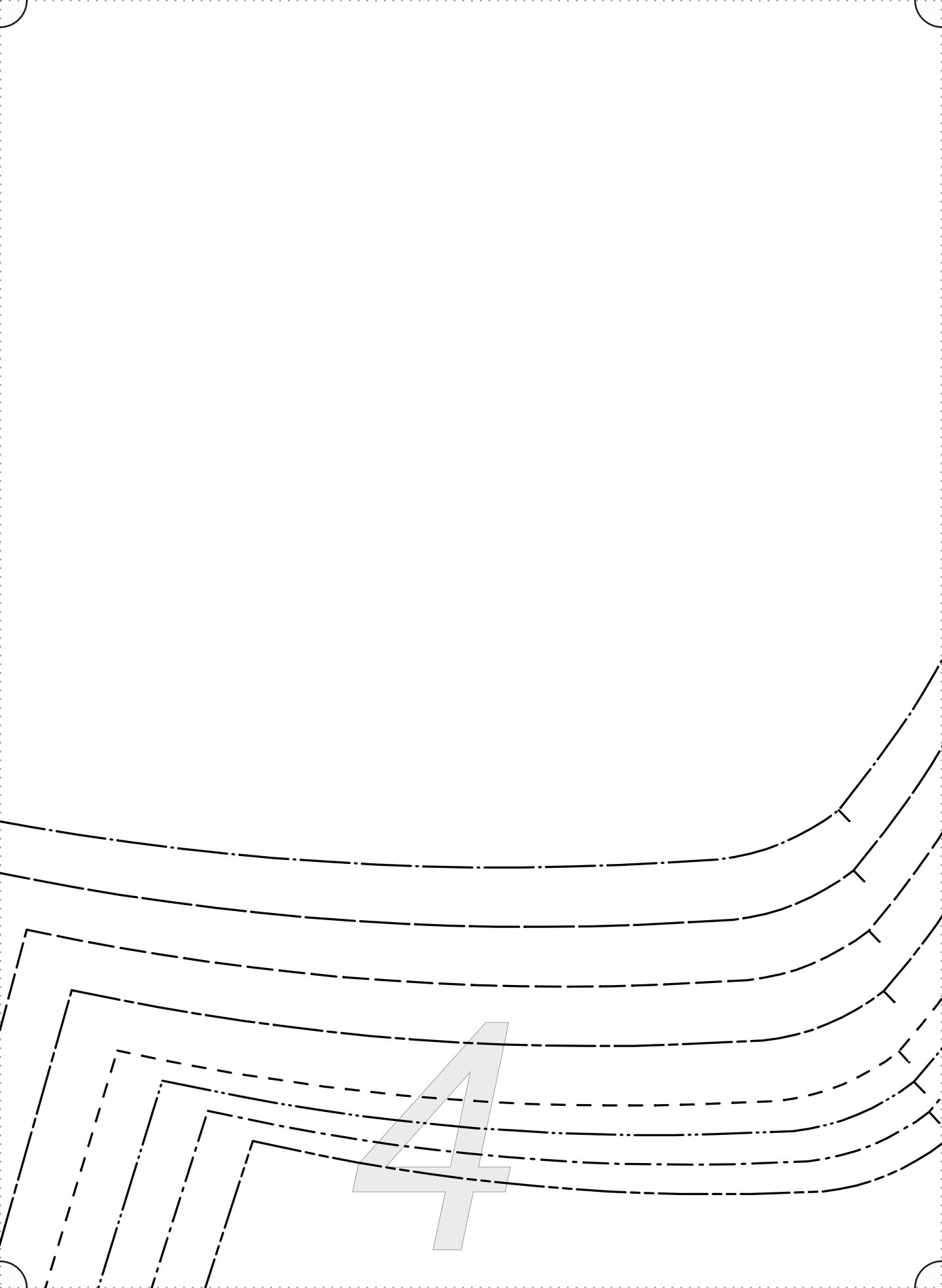

4

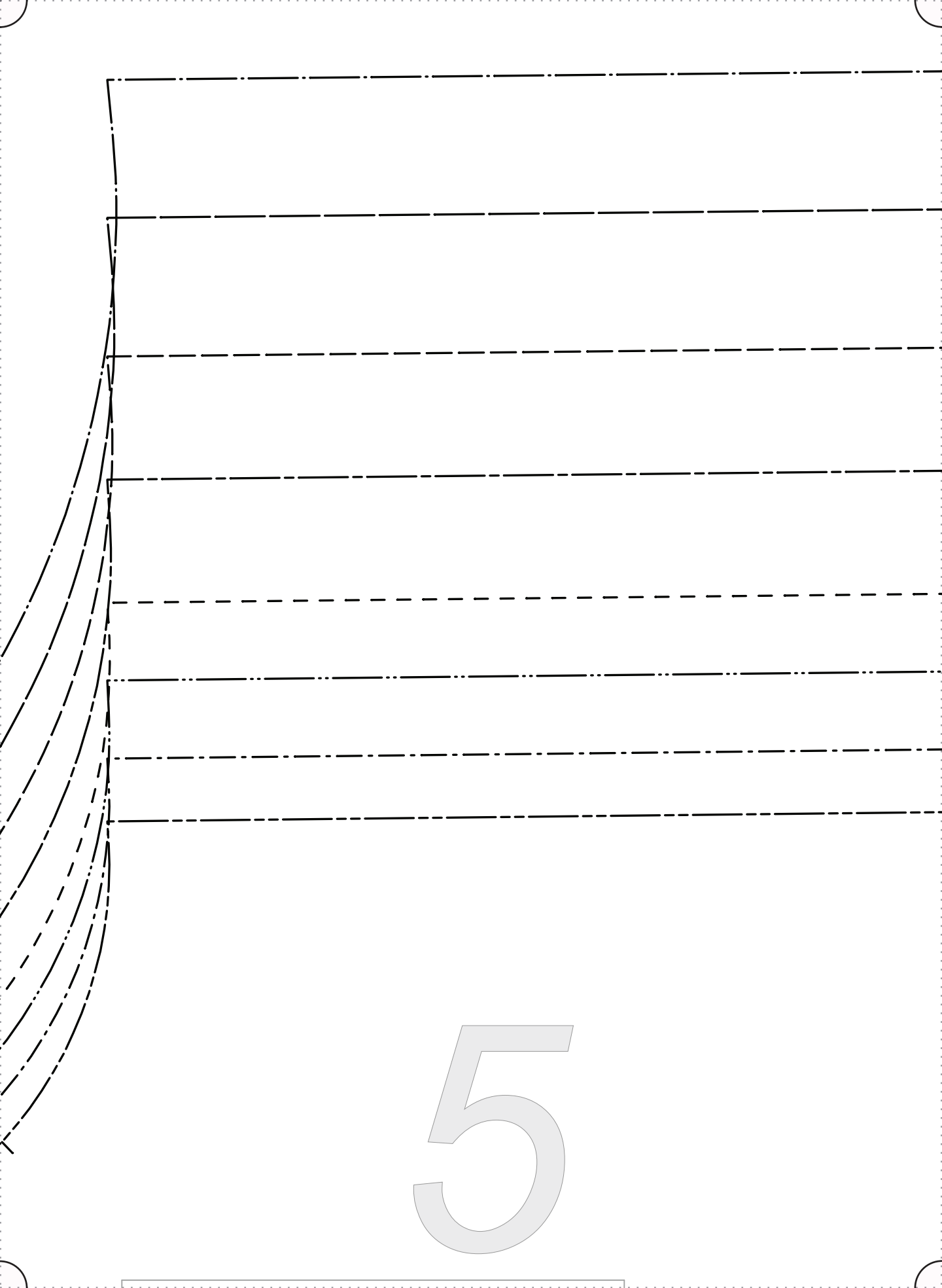

5

Handwriting practice lines consisting of six sets of horizontal lines. Each set includes a solid top line, a dashed middle line, and a solid bottom line, providing a guide for letter height and placement.

6

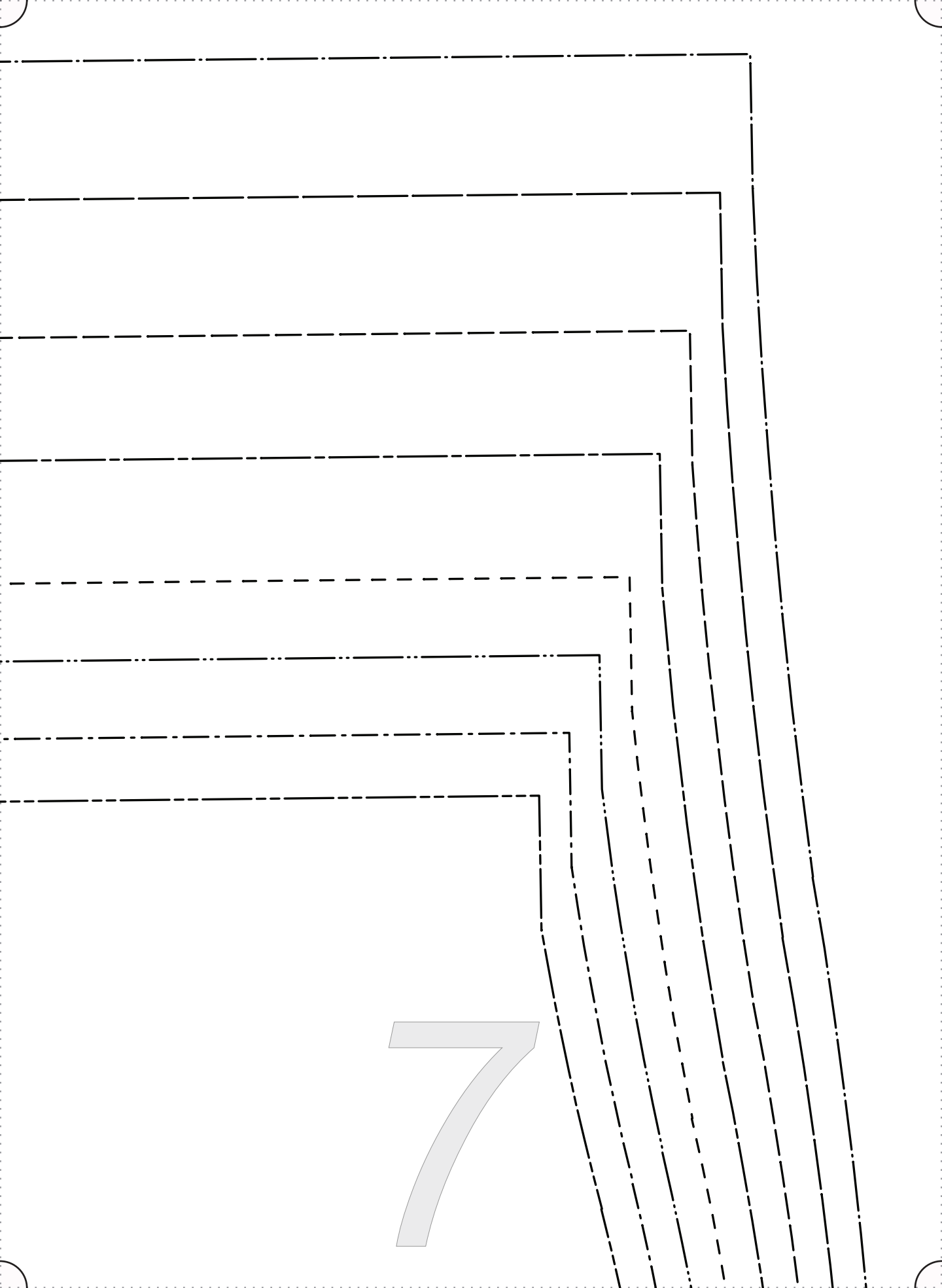

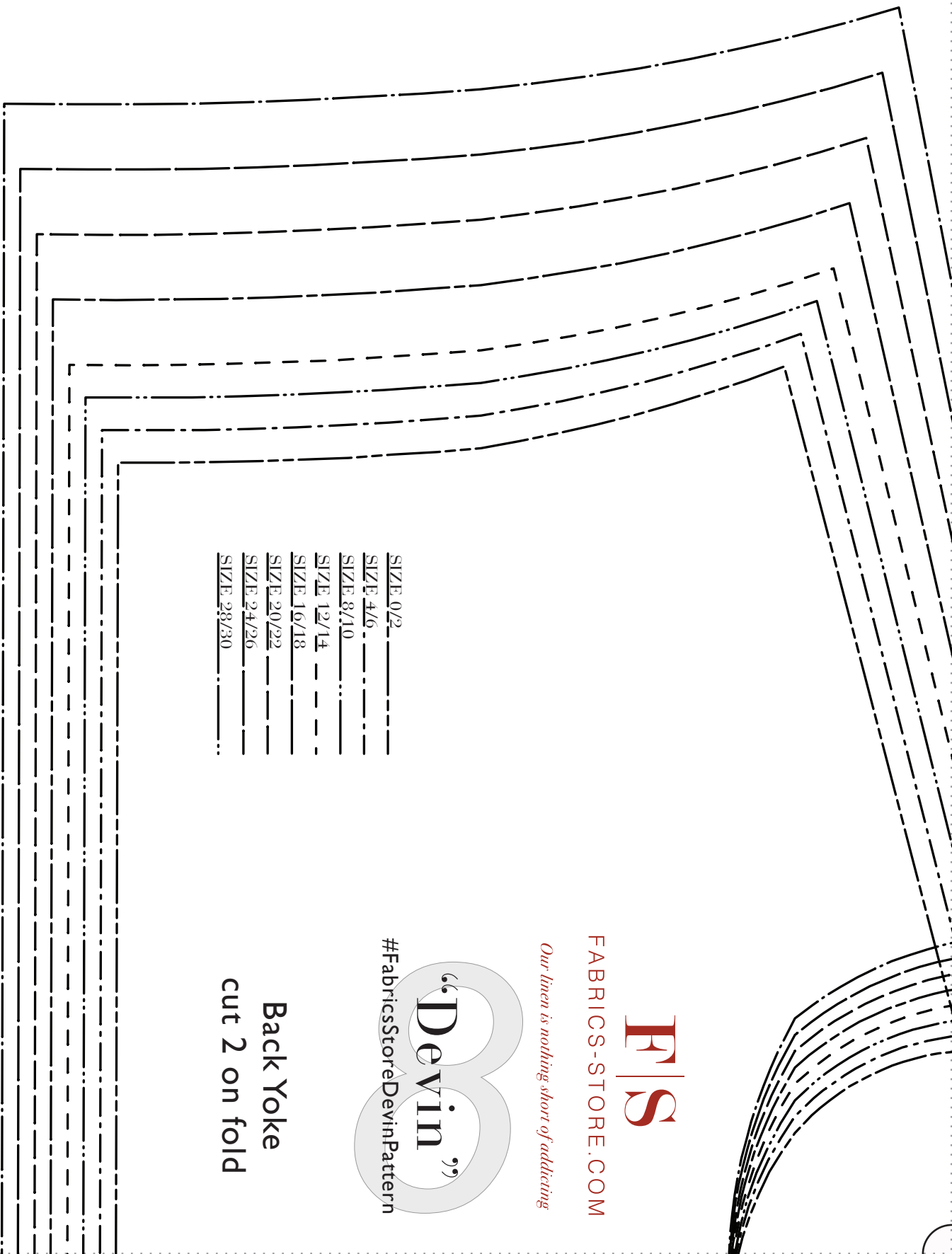

F|S

FABRICS-STORE.COM

*Our linen is nothing short of addicting*



#FabricStoreDevinPattern

- SIZE 0/2
- SIZE 4/6
- SIZE 8/10
- SIZE 12/14
- SIZE 16/18
- SIZE 20/22
- SIZE 24/26
- SIZE 28/30

Back Yoke  
cut 2 on fold

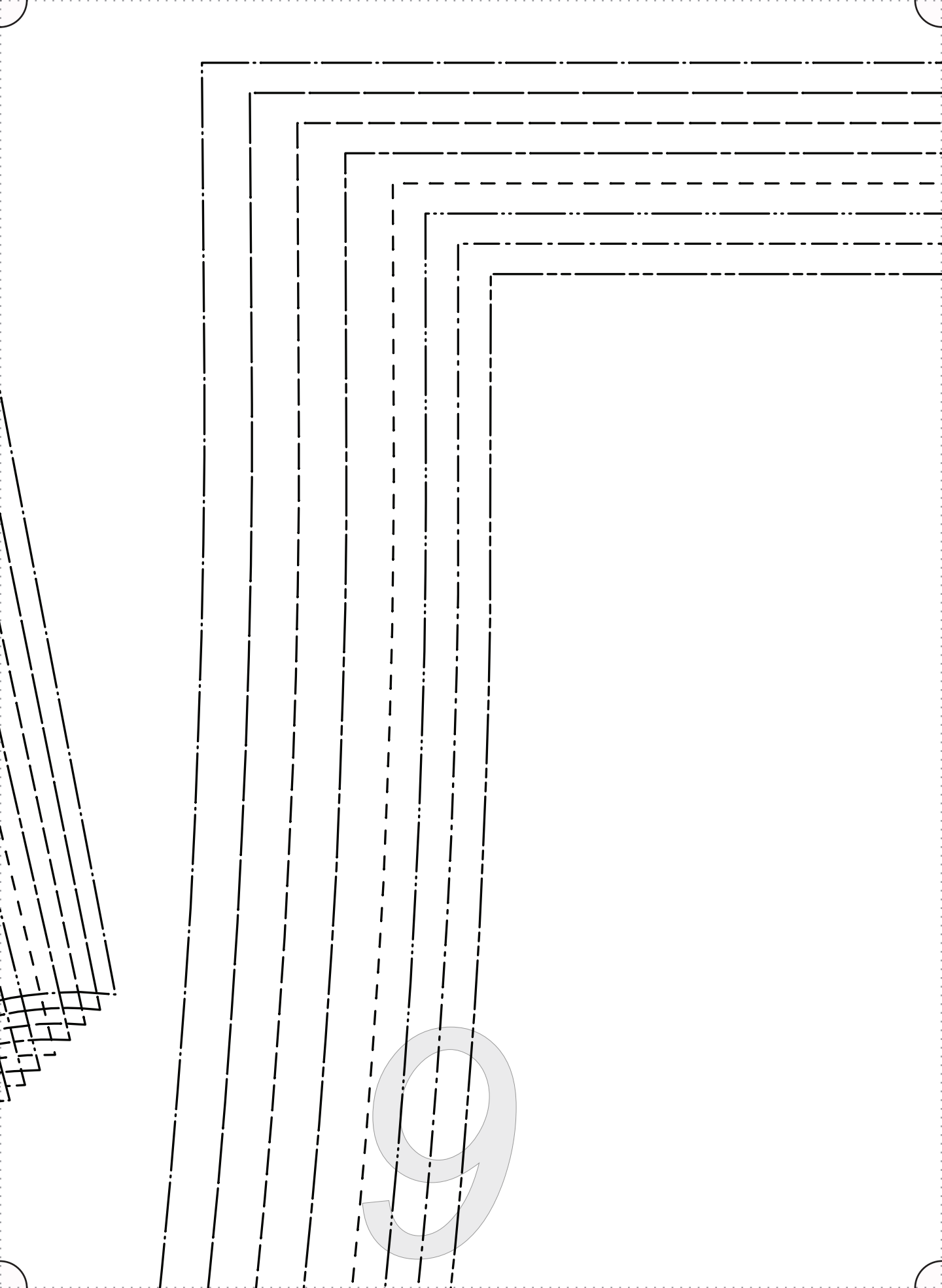

9

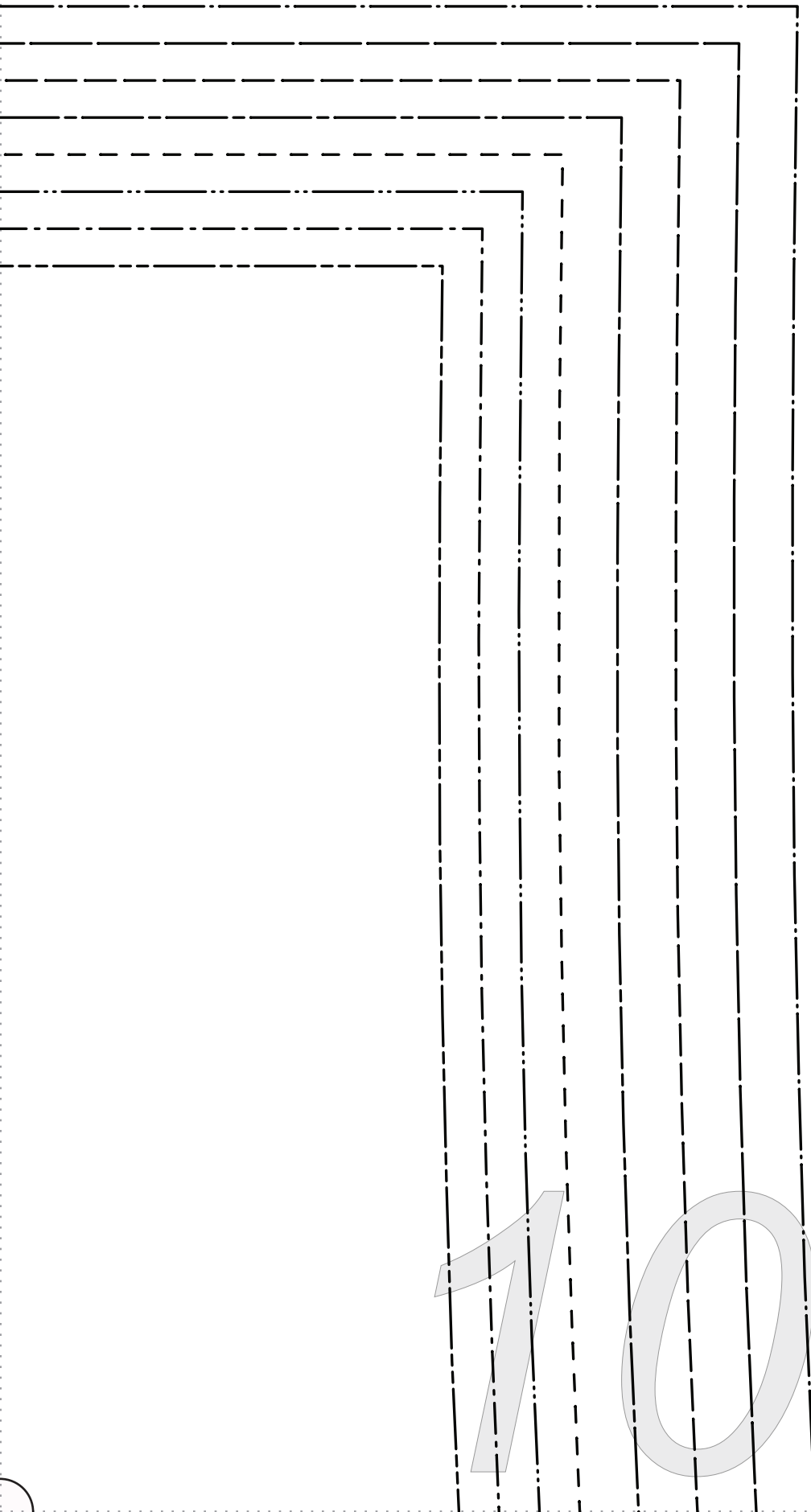

10

“Dev

#FabricsStore

Back  
cut 2 mirror

SIZE 0/2

SIZE 4/6

SIZE 8/10

SIZE 12/14

SIZE 16/18

SIZE 20/22

SIZE 24/26

SIZE 28/30



All Seam Allow

Main sea

Pant wa

Sleeve

Pant H



win”

DevinPattern

# Leg or pieces

GRAINLINE

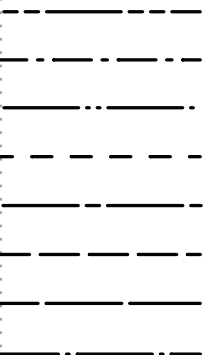

Advances Included

Seams: 3/8"

Waist: 1.75"

Hem: 1"

Hem: 1.5"

1 2

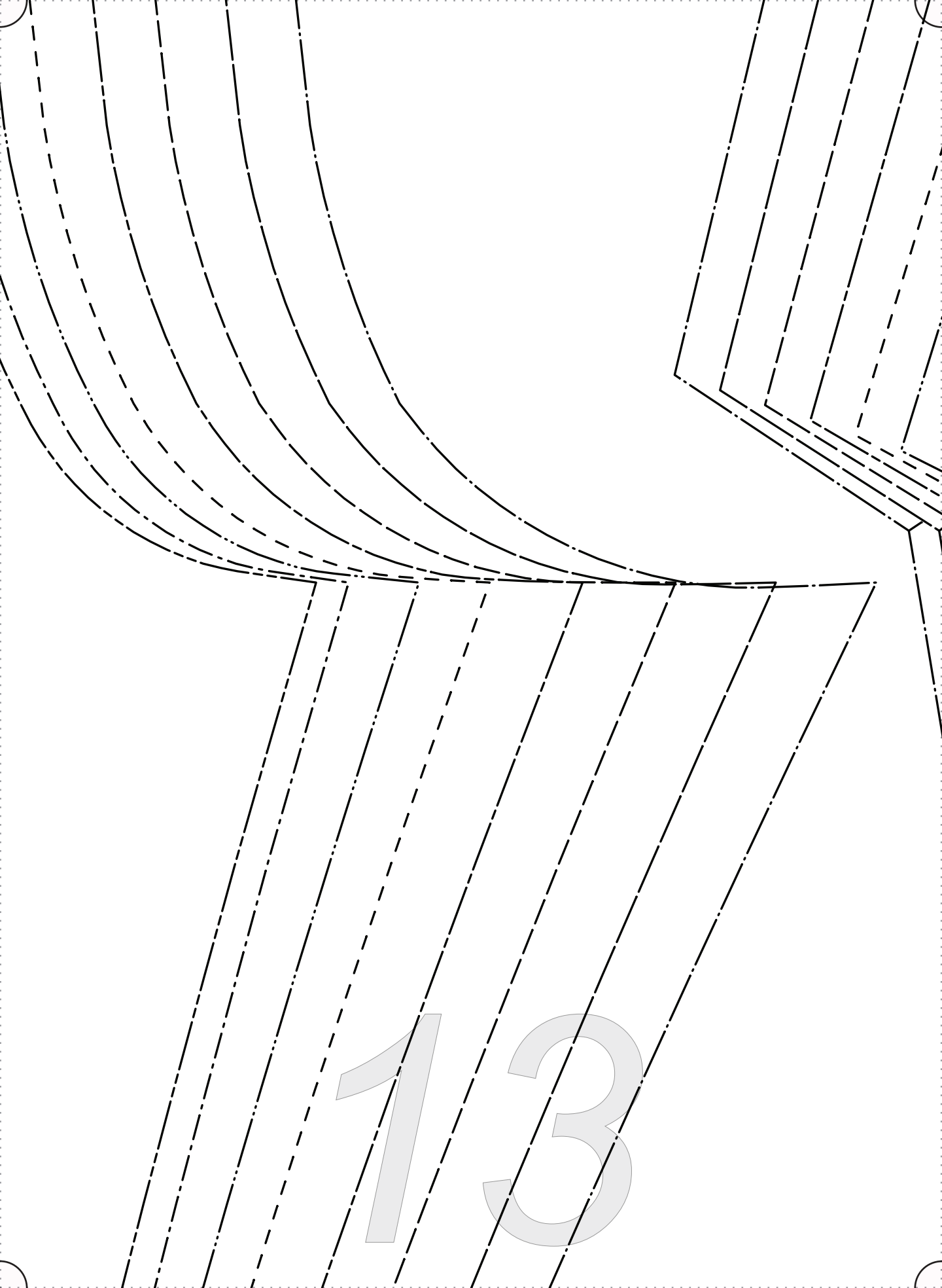

13

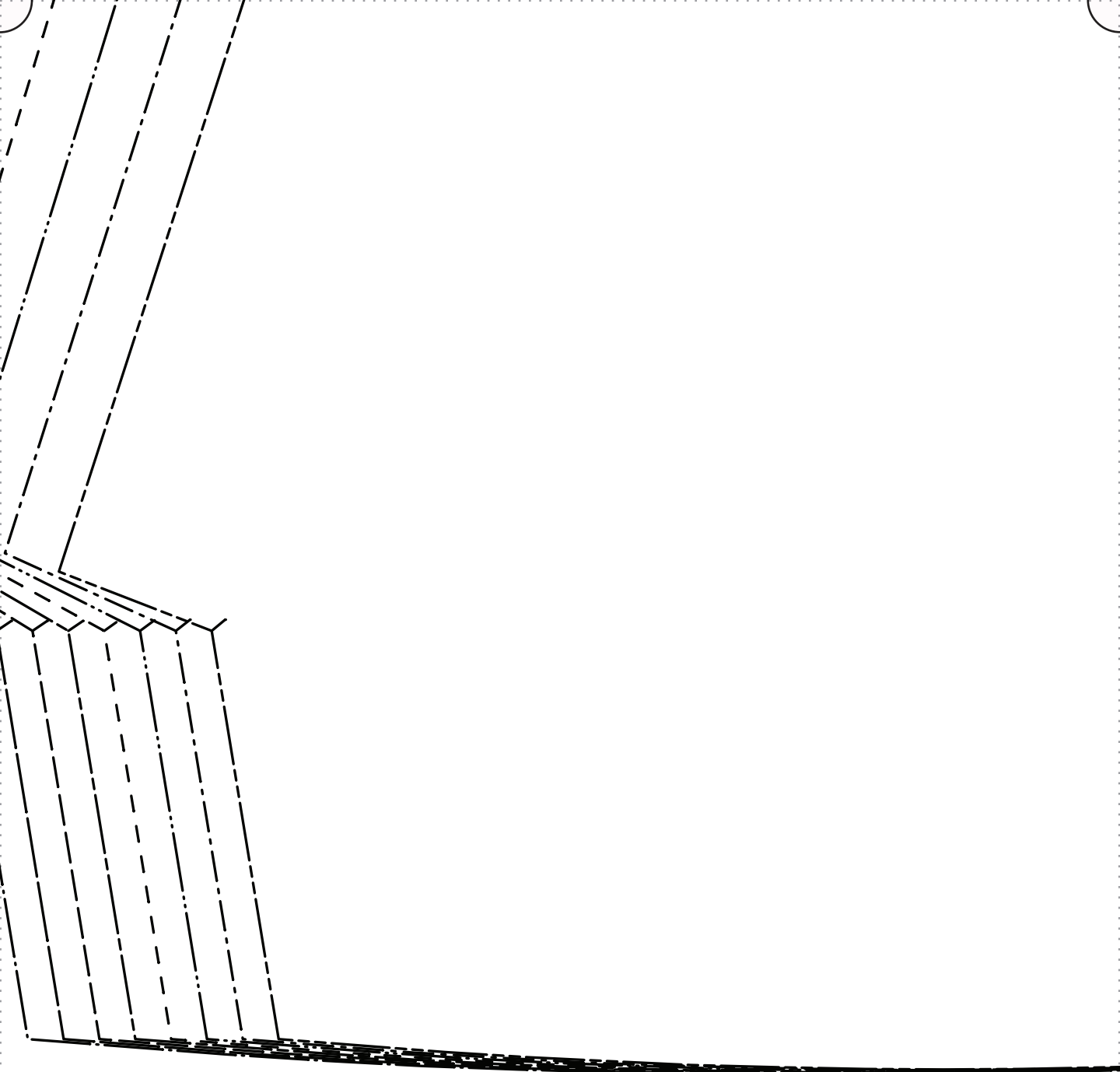

SIZE 12/14  
SIZE 16/18  
SIZE 20/22  
SIZE 24/26  
SIZE 28/30

All Seam Allowances Included

Main seams: 3/8"  
Pant waist: 1.75"  
Sleeve Hem: 1"  
Pant Hem: 1.5"

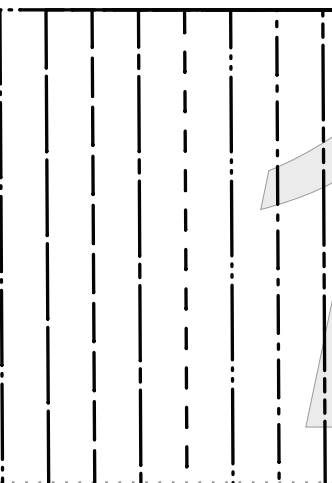
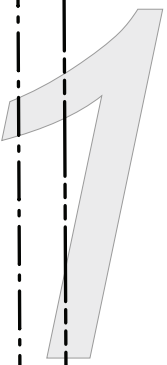

POCKET PLACEMENT



15

SIZE 0/2

SIZE 4/6

SIZE 8/10

# F|S

FABRICS-STORE.COM

*Our linen is nothing short of addicting*

# “Devin”

#FabricStoreDevinPattern

## Front Bodice cut 2 mirror pieces

SIZE 0/2

SIZE 4/6

SIZE 8/10

SIZE 12/14

SIZE 16/18

SIZE 20/22

GRAINLINE

GRAINLINE

# 16

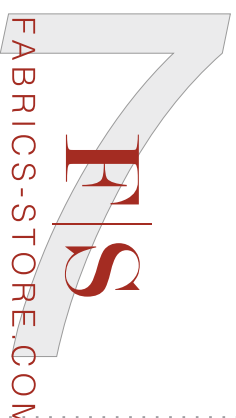

*Our linen is nothing short of addictive!*



#FabricStoreDevlinPattern

**Front Facing**  
cut 2 mirror piece  
+ 2 in interfacing

All Seam Allowances Included

Main seams: 3/8"

Pant waist: 1.75"

Sleeve Hem: 1"

Pant Hem: 1.5"

SIZE 24/26

SIZE 28/30



CUT ON FOLD OF FABRIC

F|S

FABRICS-STORE.COM

*Our linen is nothing short of addicting*

“Devin”

#FabricStoreDevinPattern

Left Pocket – cut 1



GRAINLINE

18

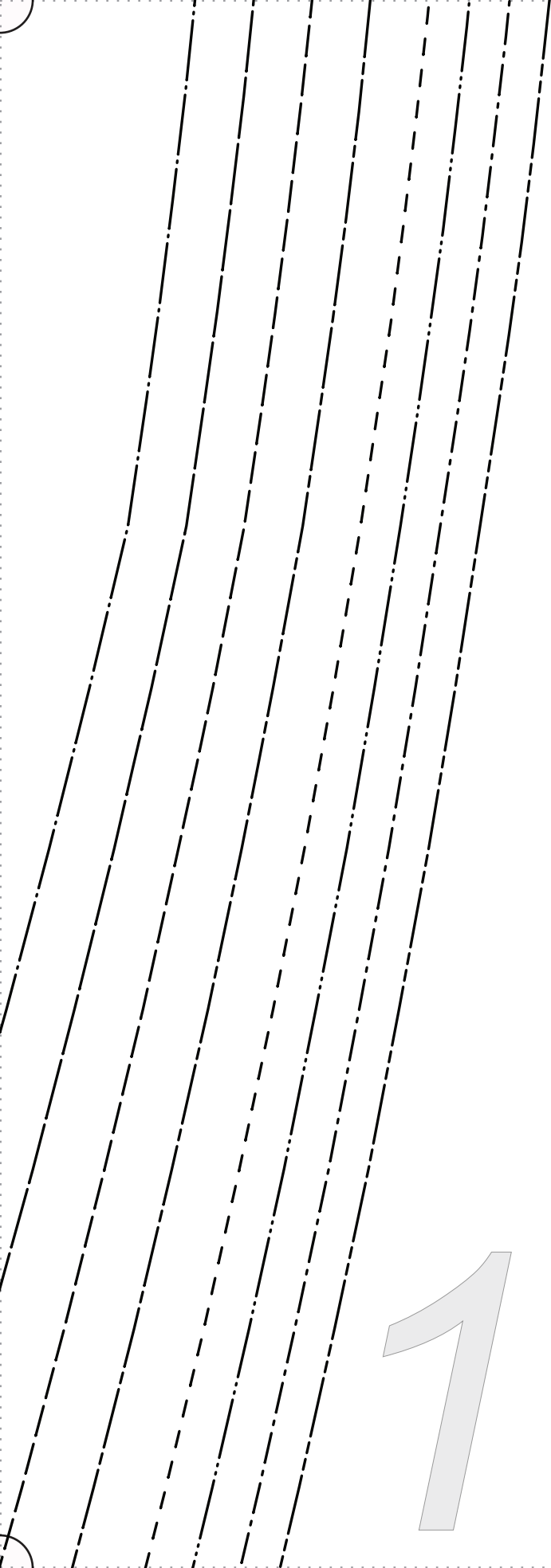

19



20

21



22

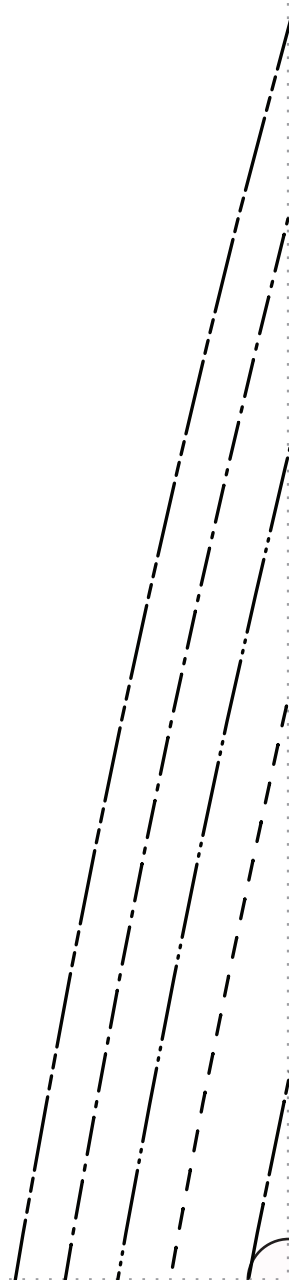

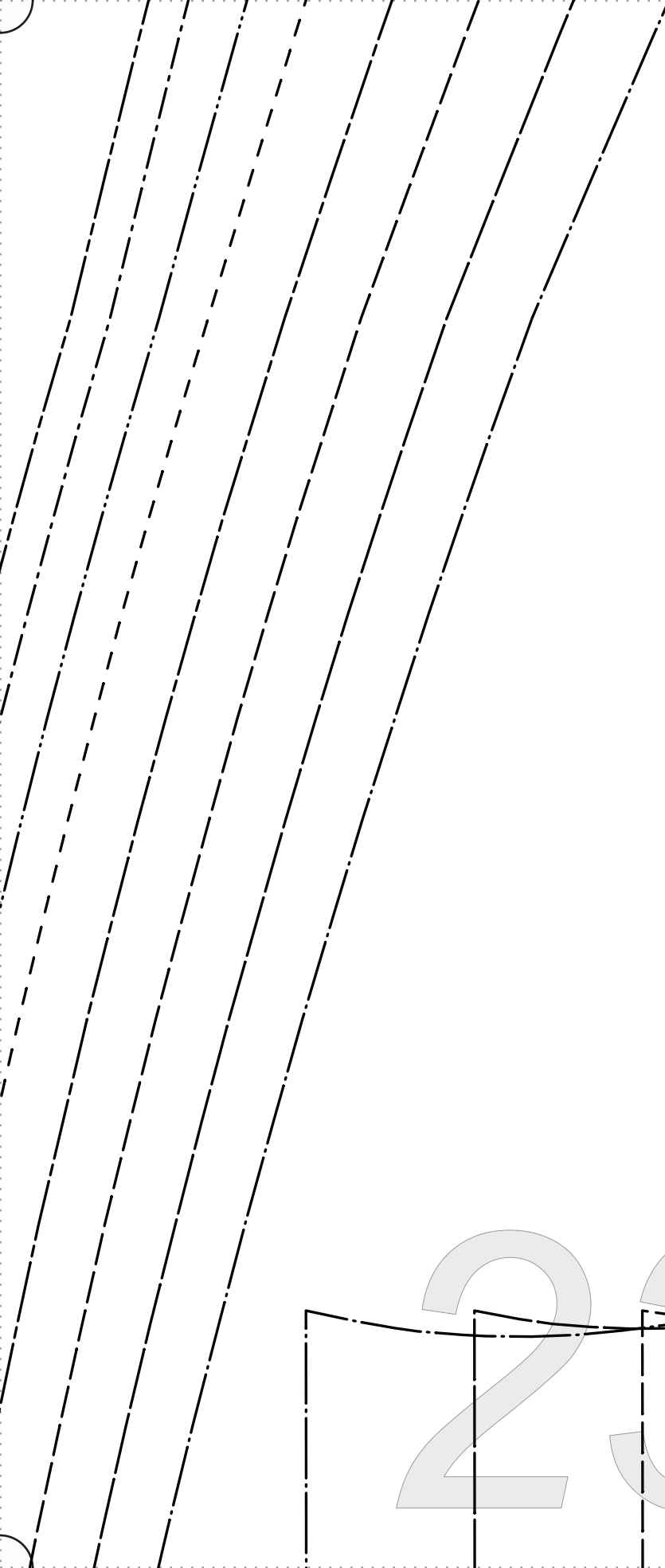
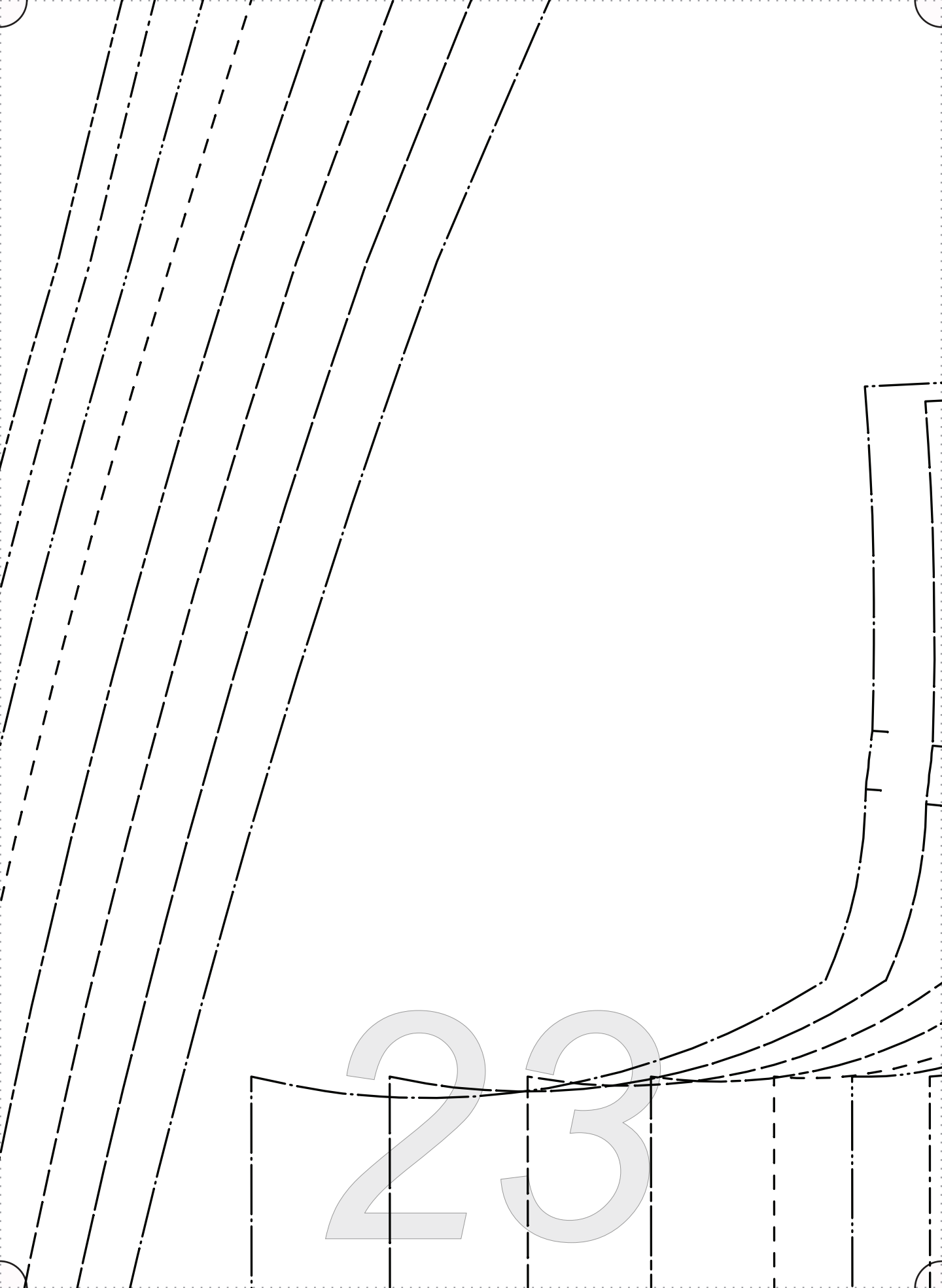

23

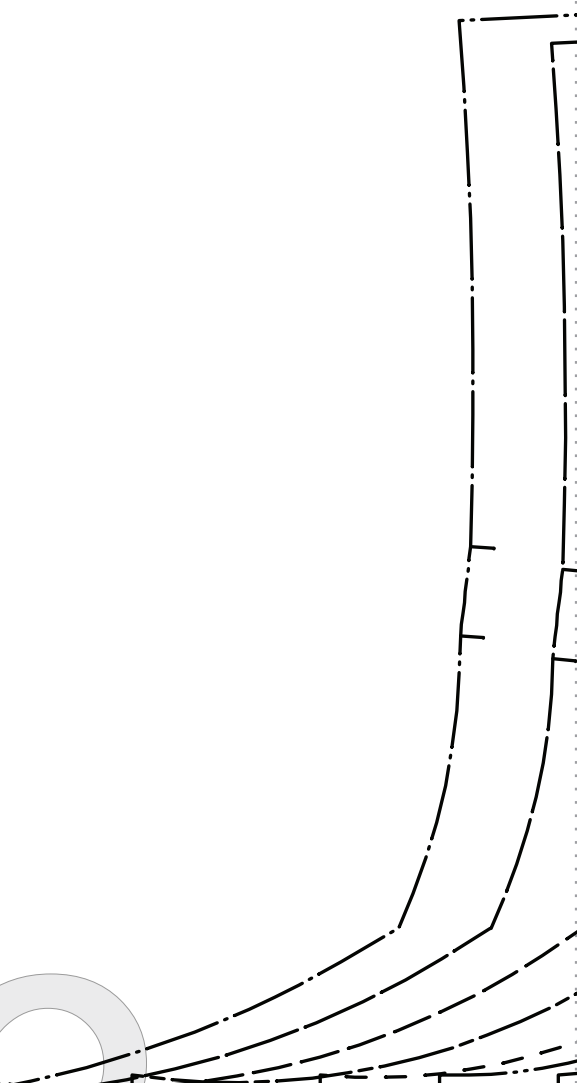

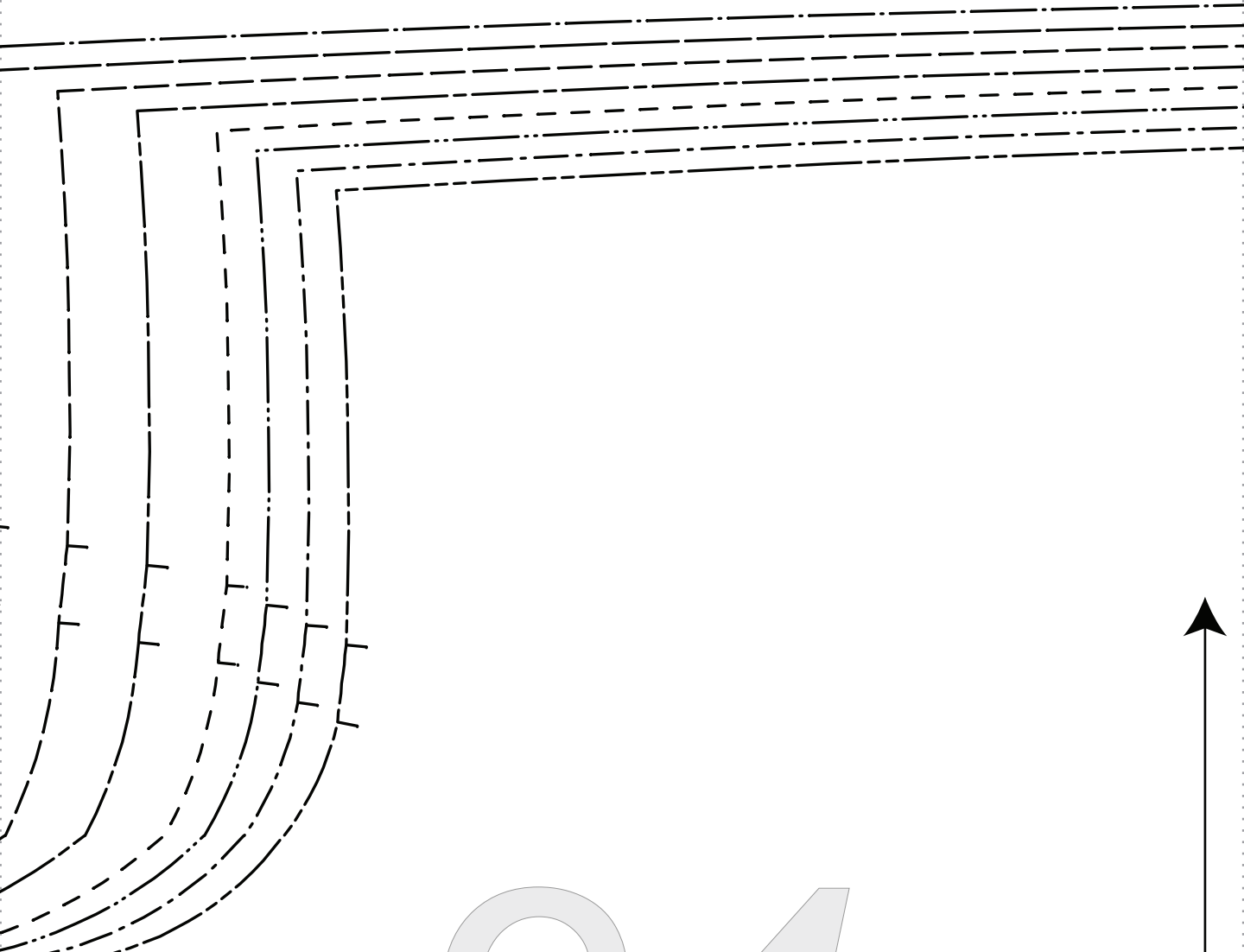

24  
F|S

FABRICS-STORE.COM

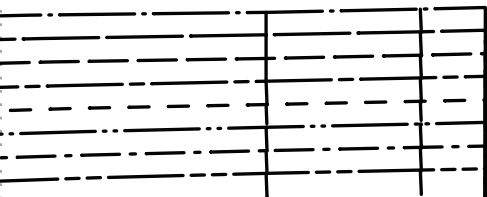

25



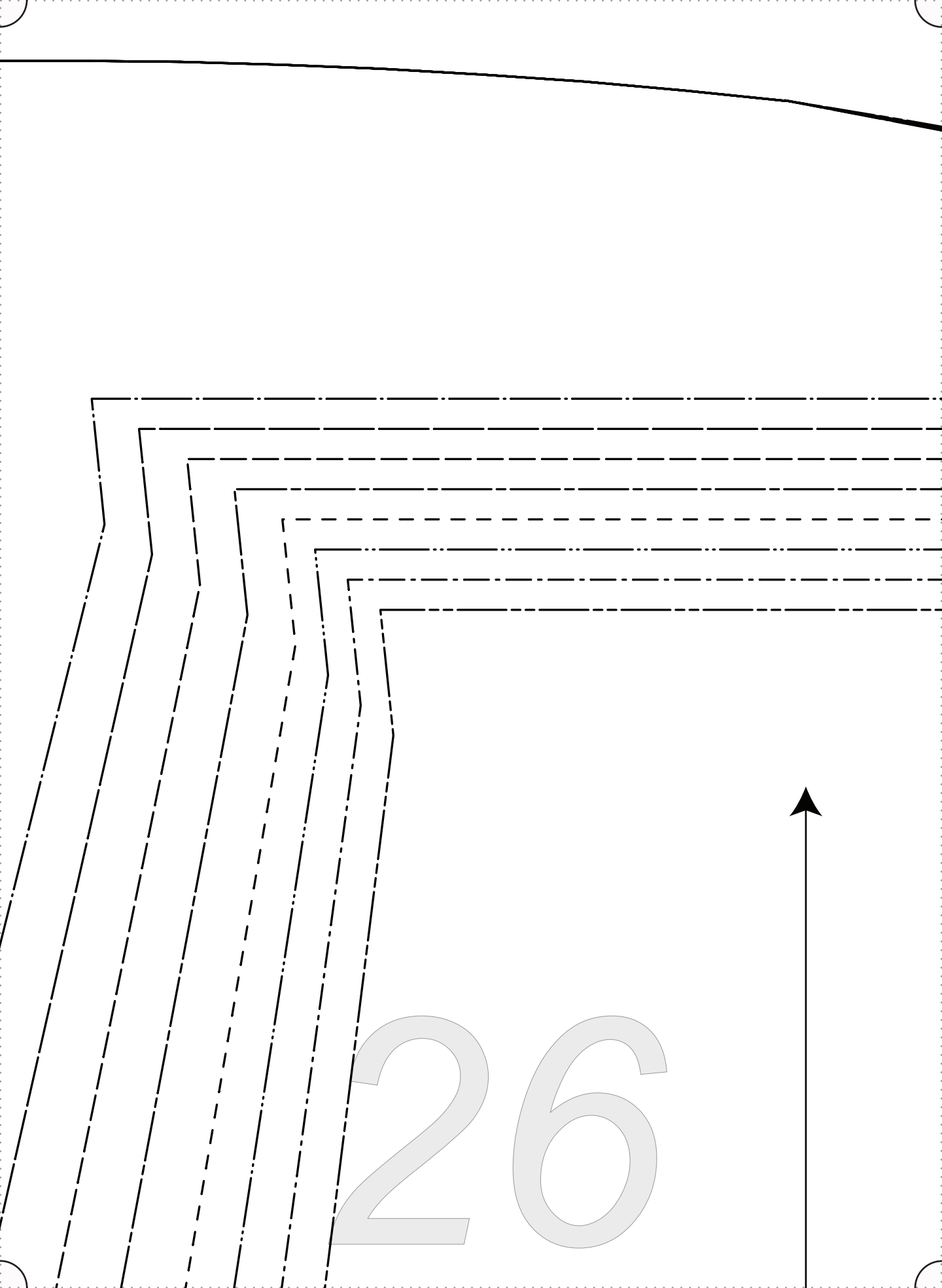

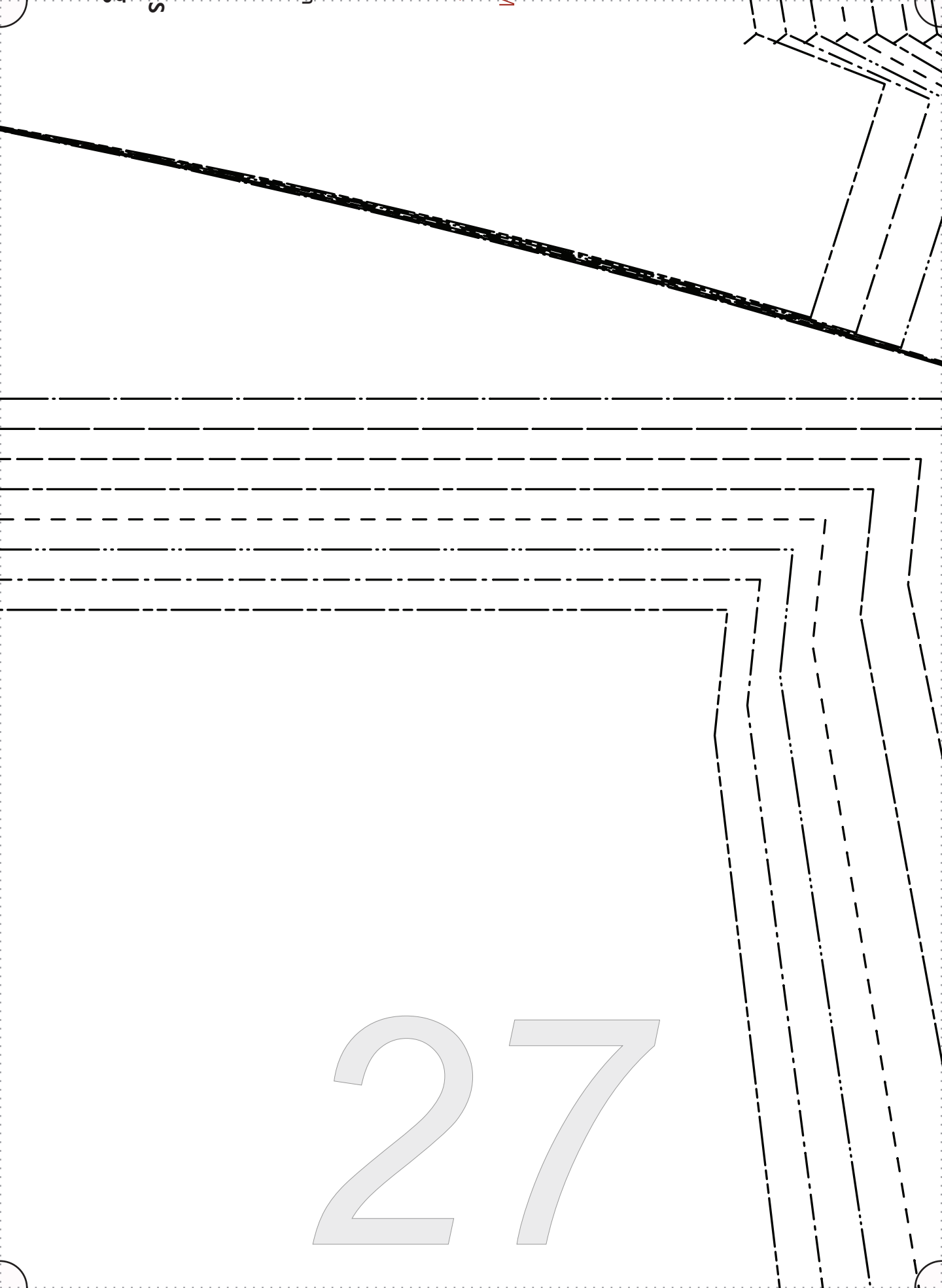

27





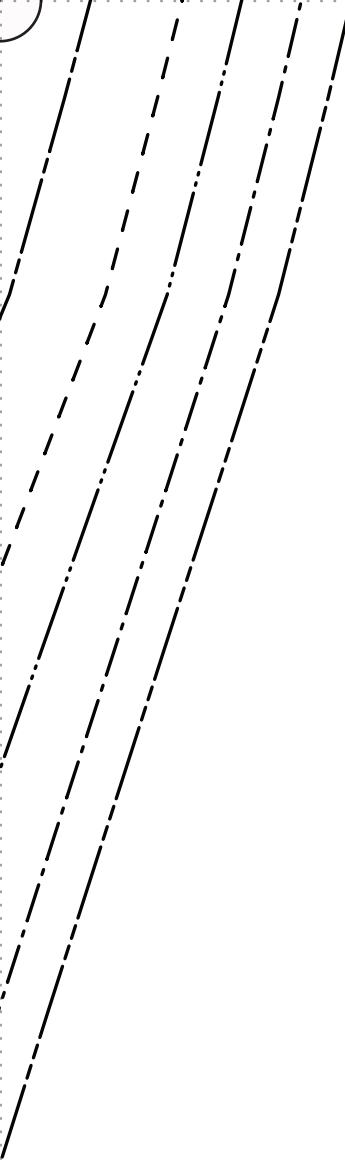

29

GRAIN

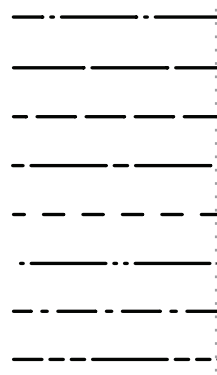

Advances Included  
Stams: 3/8"  
Dist: 1.75"  
Hem: 1"  
em: 1.5"

30

SIZE 0/2  
SIZE 4/6  
SIZE 8/10  
SIZE 12/14  
SIZE 16/18  
SIZE 20/22  
SIZE 24/26  
SIZE 28/30

All Seam Allow  
Main se  
Pant wa  
Sleeve  
Pant H

3 1

3 2

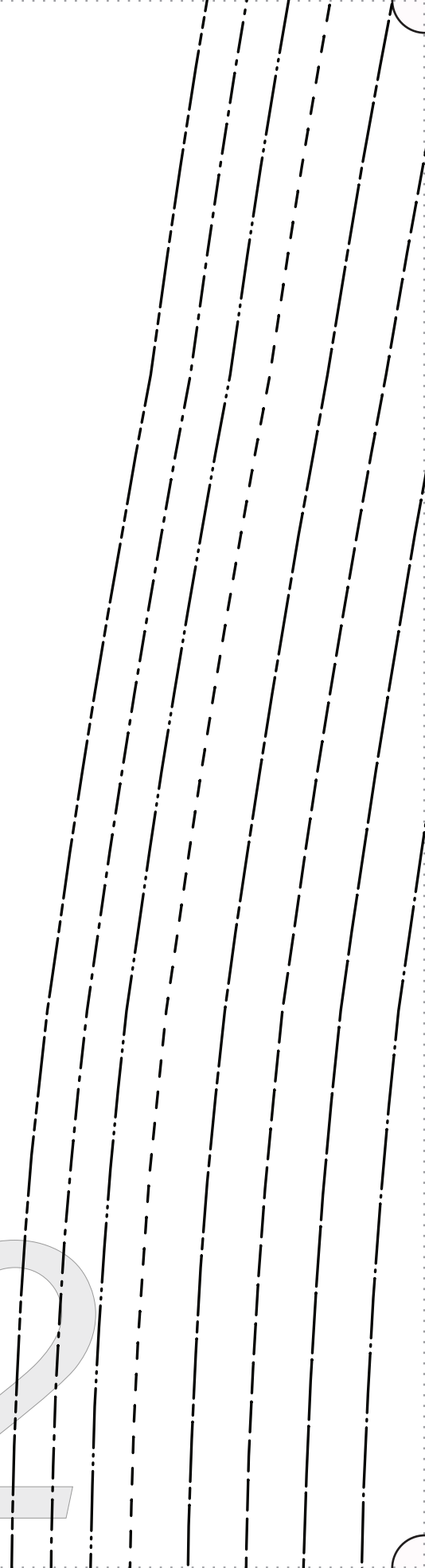

3 3

*Our linen is nothing short of addicting*

# “Devin”

#FabricStoreDevinPattern

Back Bodice  
cut 1 on fold

SIZE 0/2 \_\_\_\_\_

SIZE 4/6 \_\_\_\_\_

SIZE 8/10 \_\_\_\_\_

SIZE 12/14 \_\_\_\_\_

SIZE 16/18 \_\_\_\_\_

SIZE 20/22 \_\_\_\_\_

SIZE 24/26 \_\_\_\_\_

SIZE 28/30 \_\_\_\_\_

GRAINLINE

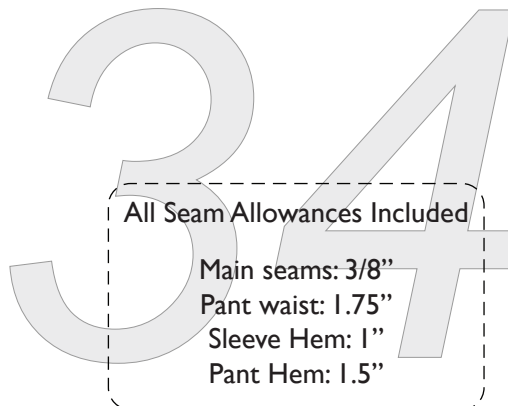

CUT ON FOLD OF FABRIC

35

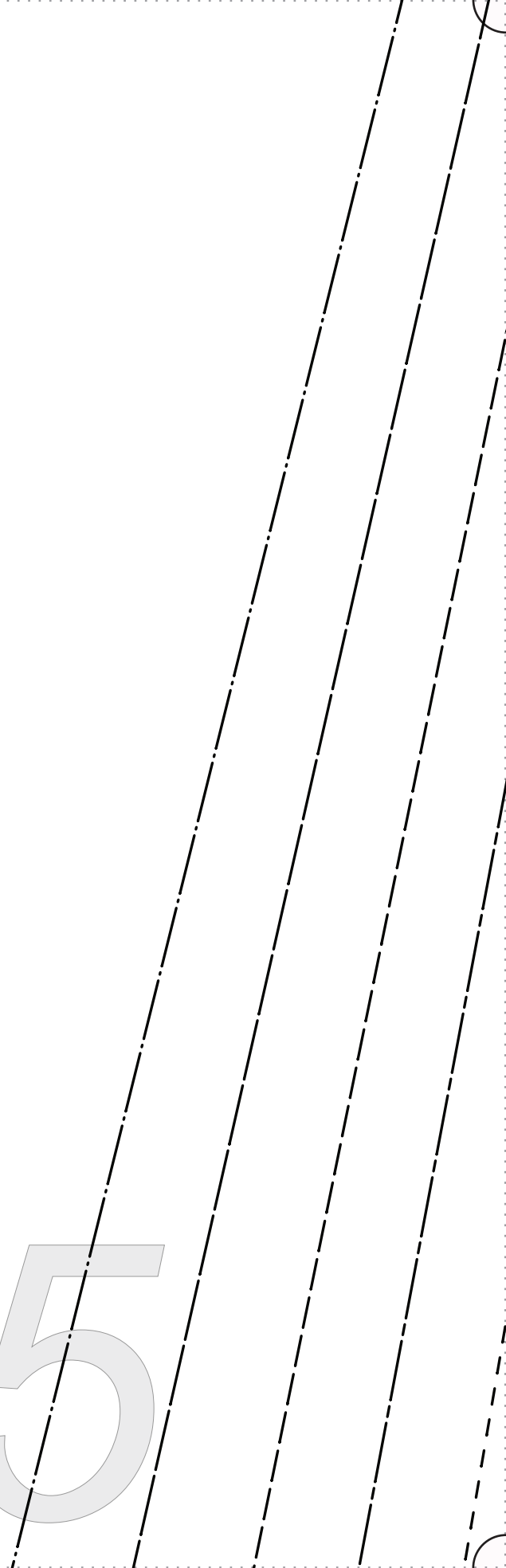



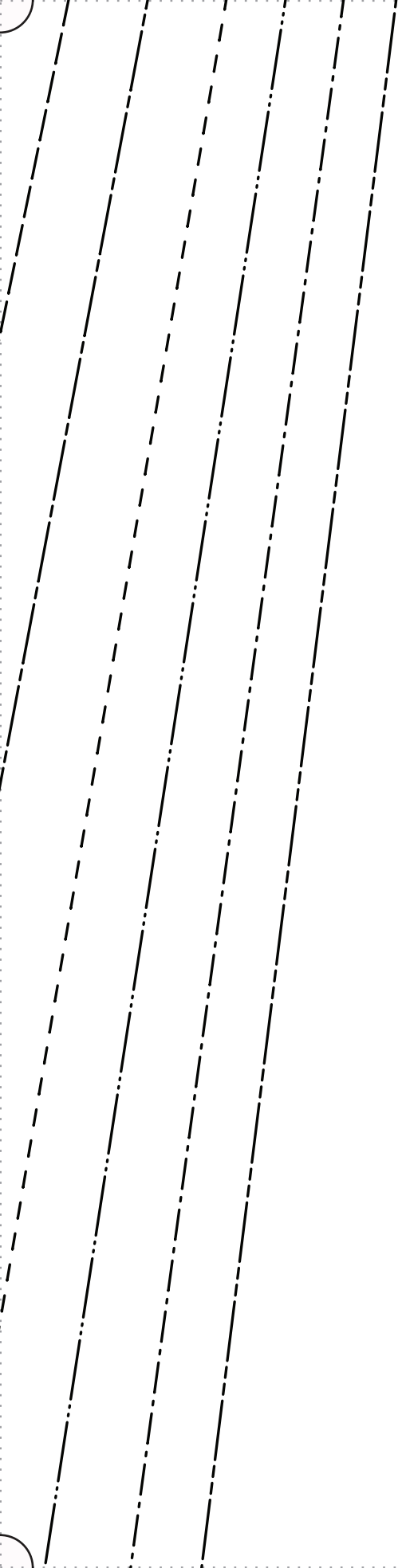

36

GRAINLINE

# 37

## Sleeve

Cut 2 mirror pieces

- SIZE 0/2
- SIZE 4/6
- SIZE 8/10
- SIZE 12/14
- SIZE 16/18
- SIZE 20/22
- SIZE 24/26
- SIZE 28/30

All Seam Allowances Included  
Main seams: 3/8"  
Pant waist: 1.75"  
Sleeve Hem: 1"  
Pant Hem: 1.5"

38

or pieces  
t Leg

Dev in Pattern

WIN

*short of adding*

TORE.COM

S

LINE

39

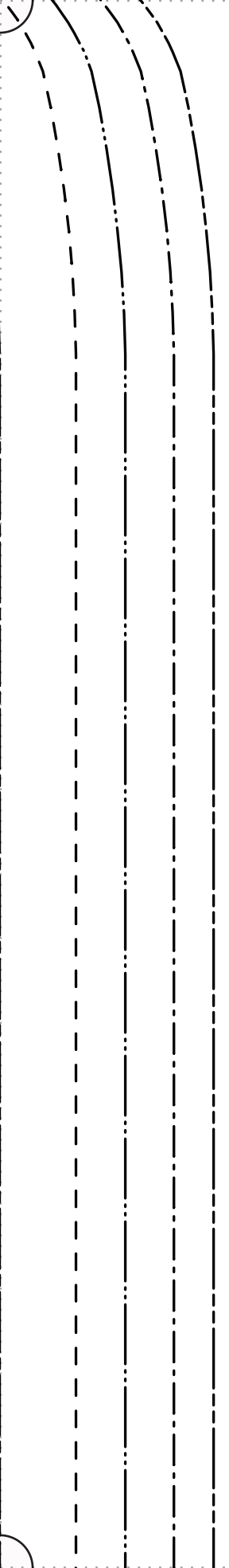

40

F

FABRICS-S

*Our linen is nothing*

“DeV

#FabricStore

Front  
cut 2 mirr

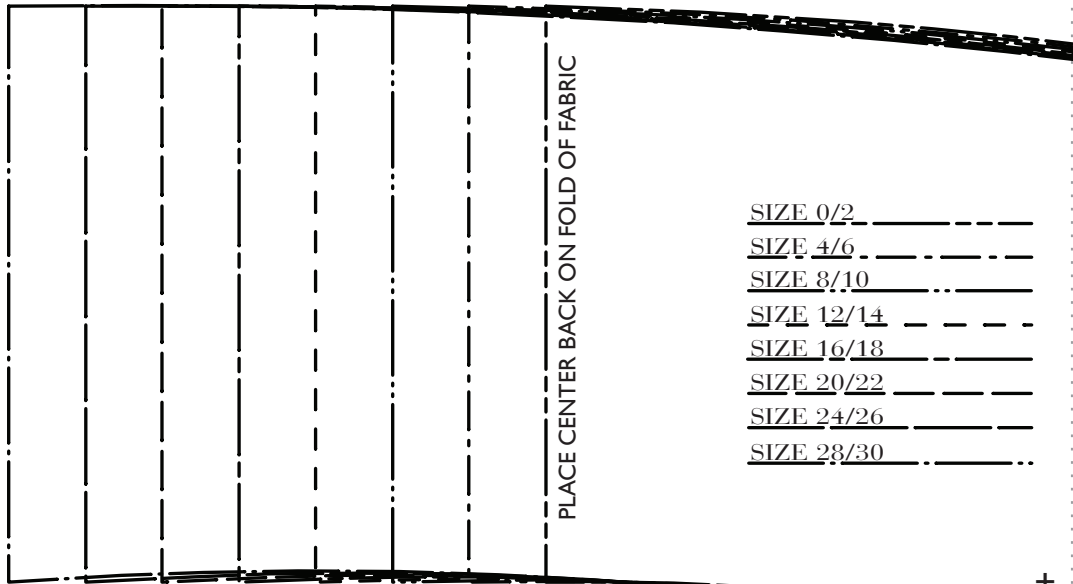
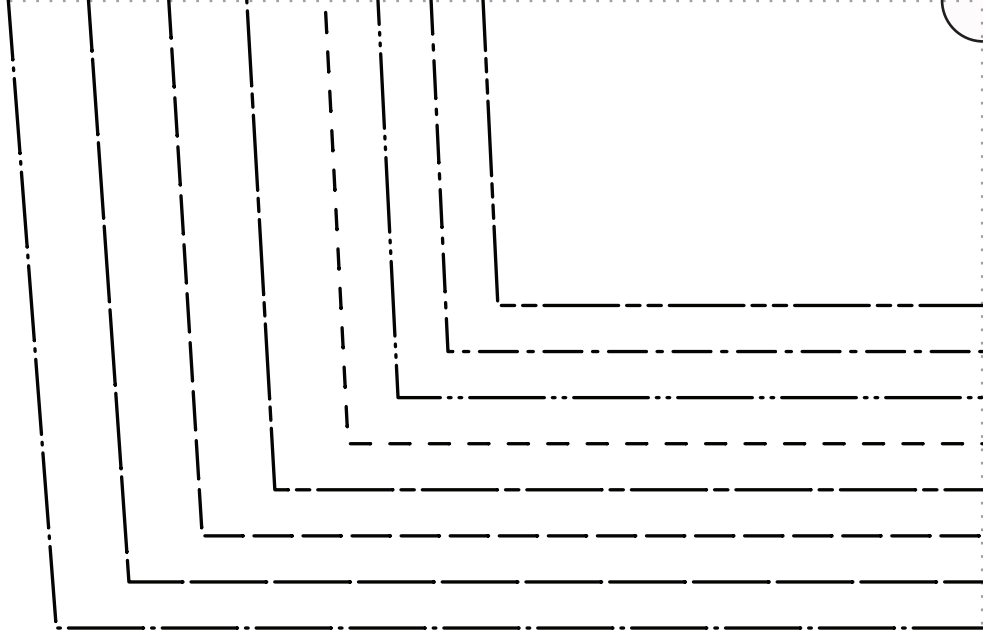

SIZE 0/2 \_\_\_\_\_  
SIZE 4/6 \_\_\_\_\_  
SIZE 8/10 \_\_\_\_\_  
SIZE 12/14 \_\_\_\_\_  
SIZE 16/18 \_\_\_\_\_  
SIZE 20/22 \_\_\_\_\_  
SIZE 24/26 \_\_\_\_\_  
SIZE 28/30 \_\_\_\_\_

41



**F|S**

FABRICS-STORE.COM

*Our linen is nothing short of addictive*

“Devin”

#FabricStoreDevinPattern

Collar - cut 2 on fold

1 in interfacing (for under collar)

42

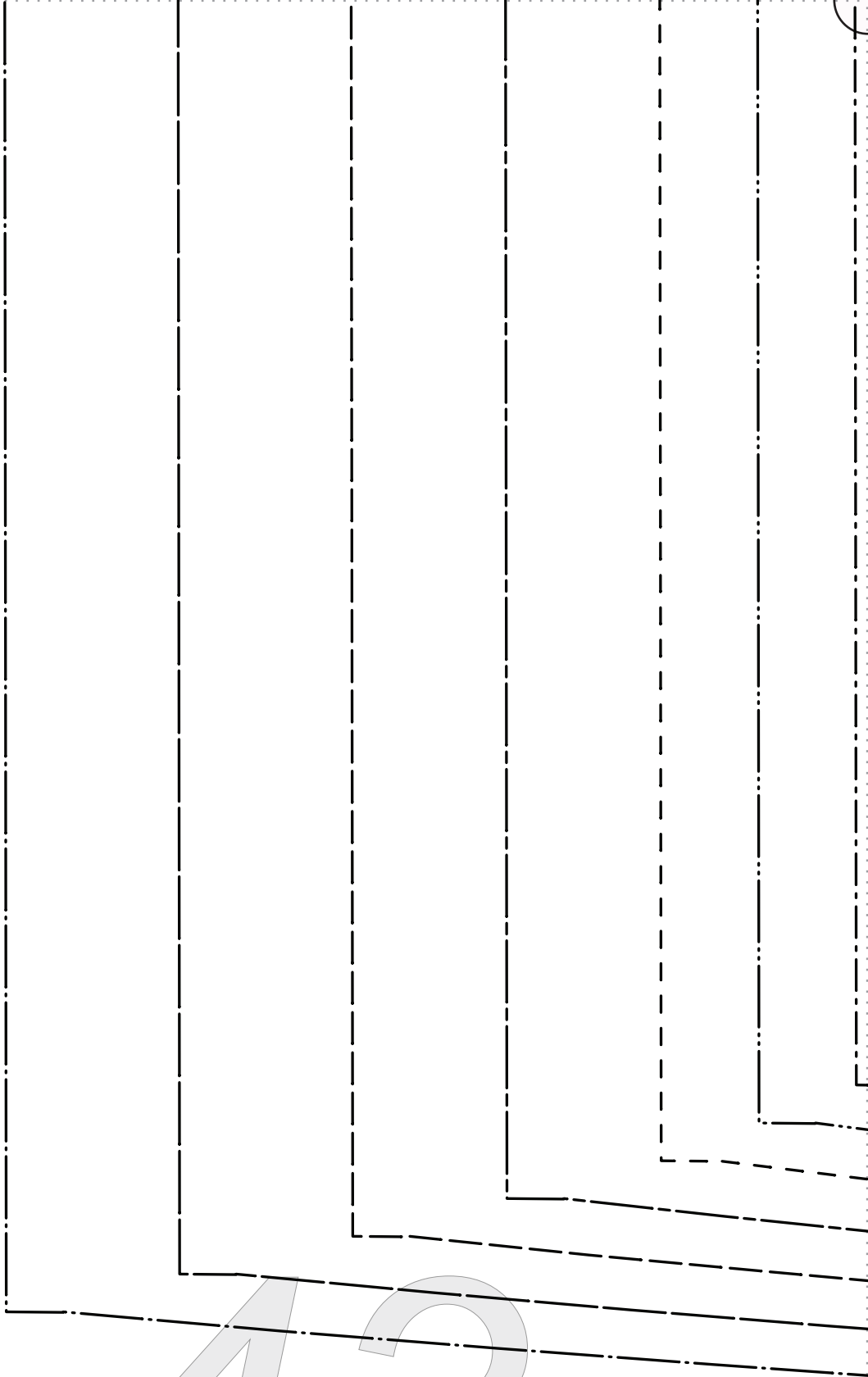

43





44

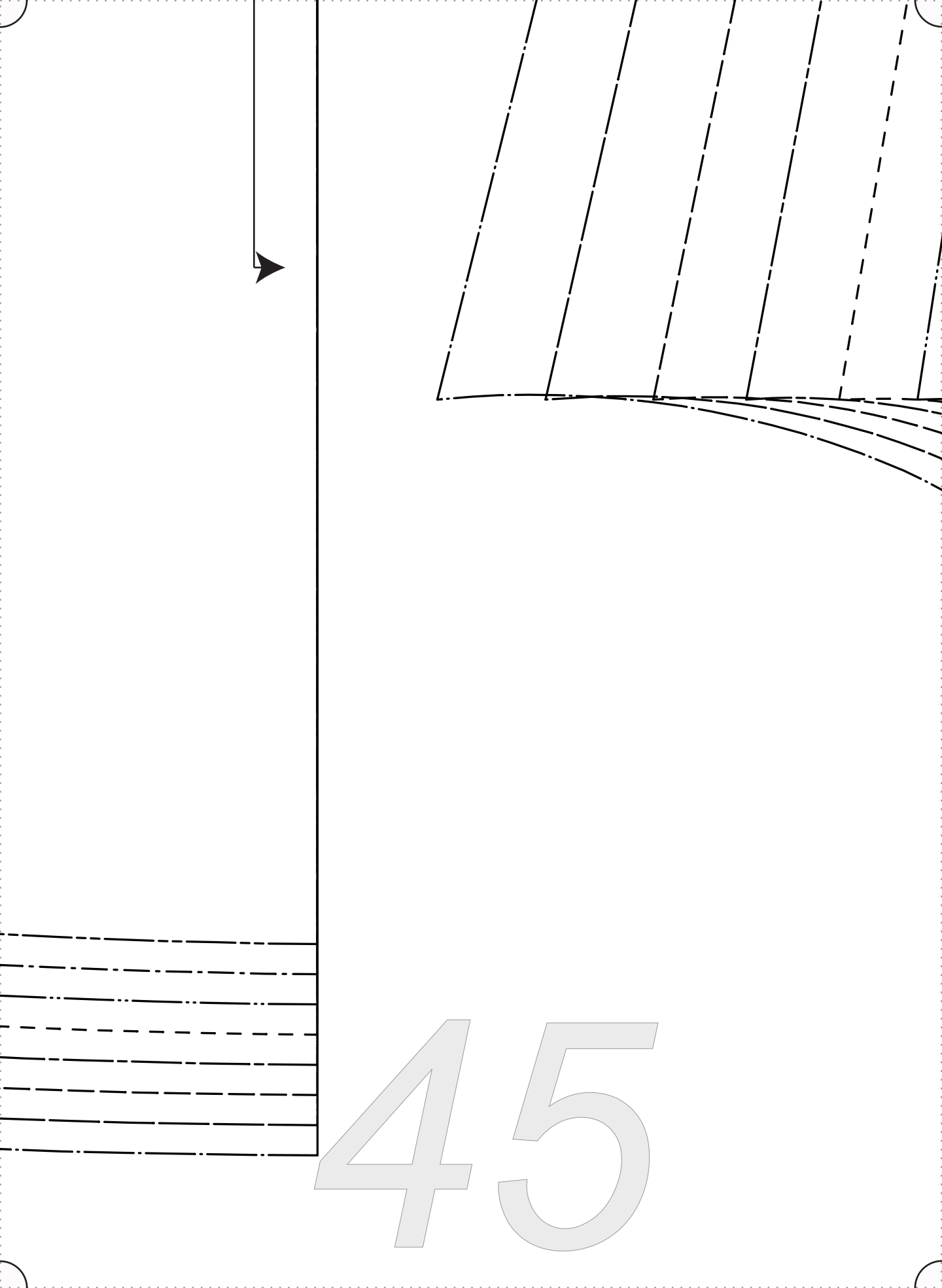

45

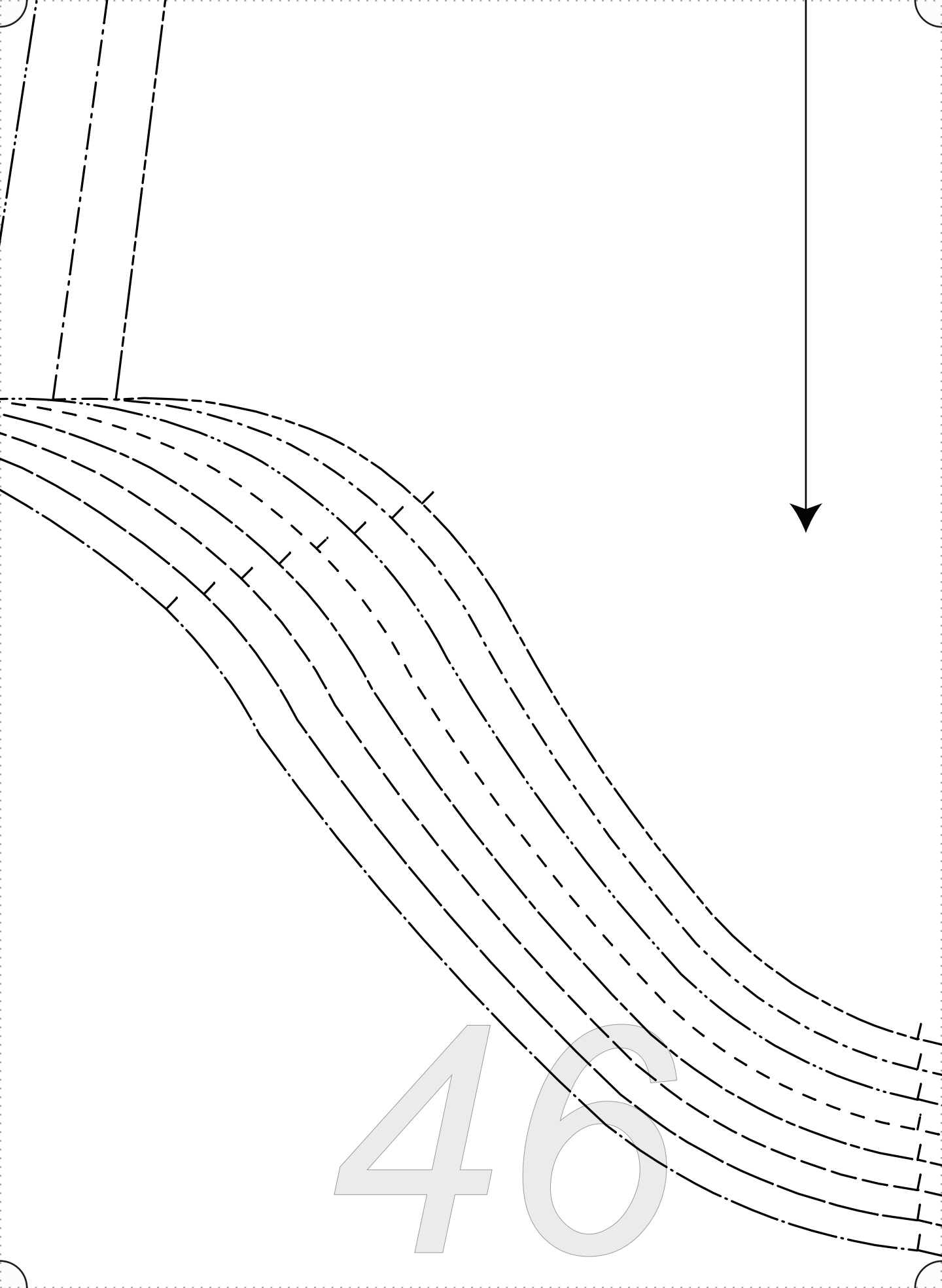

46

“Devlin”

*Our linen is nothing short of addicting*

FABRICS-STORE.COM

F|S

47

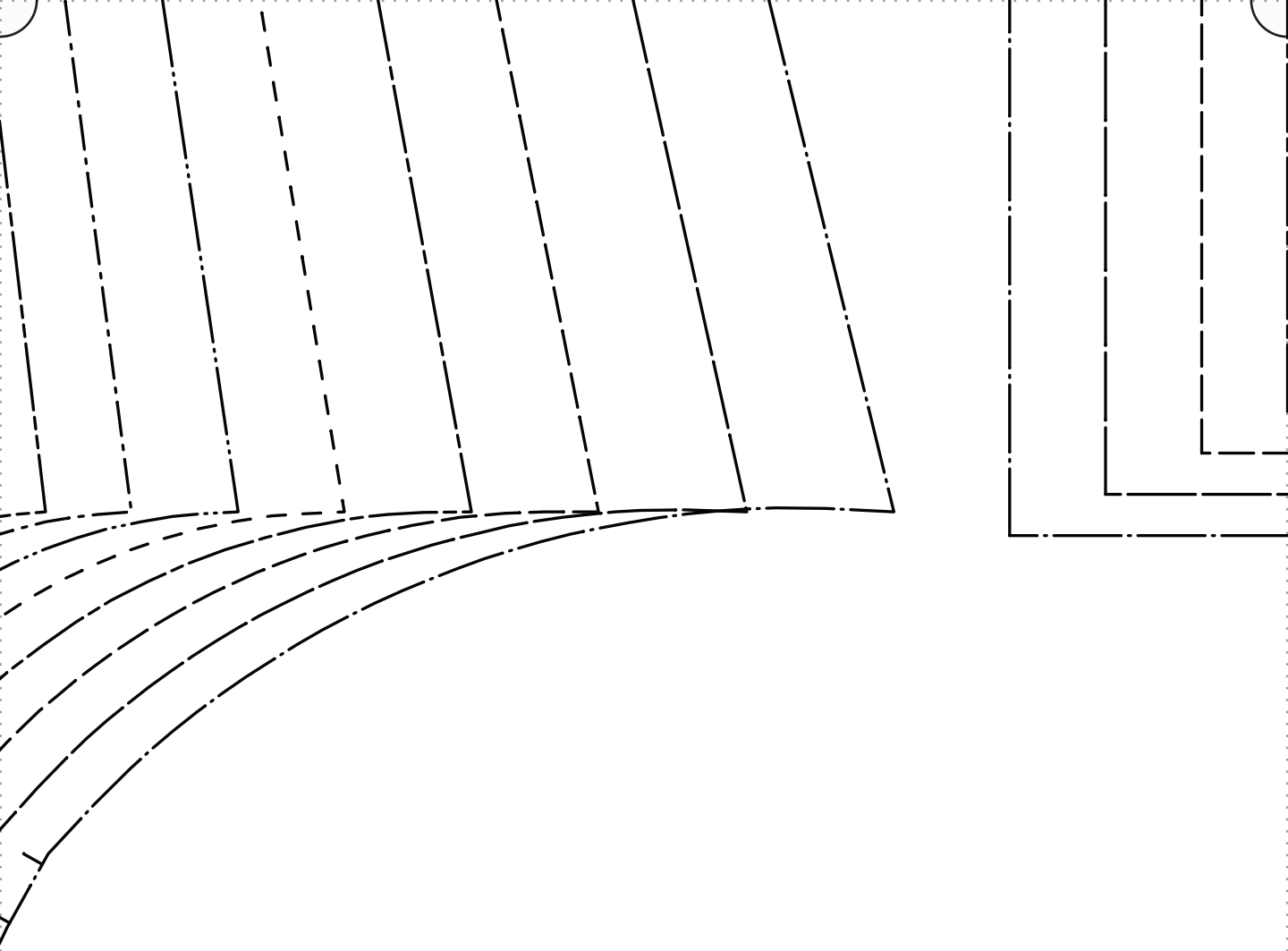

48

49

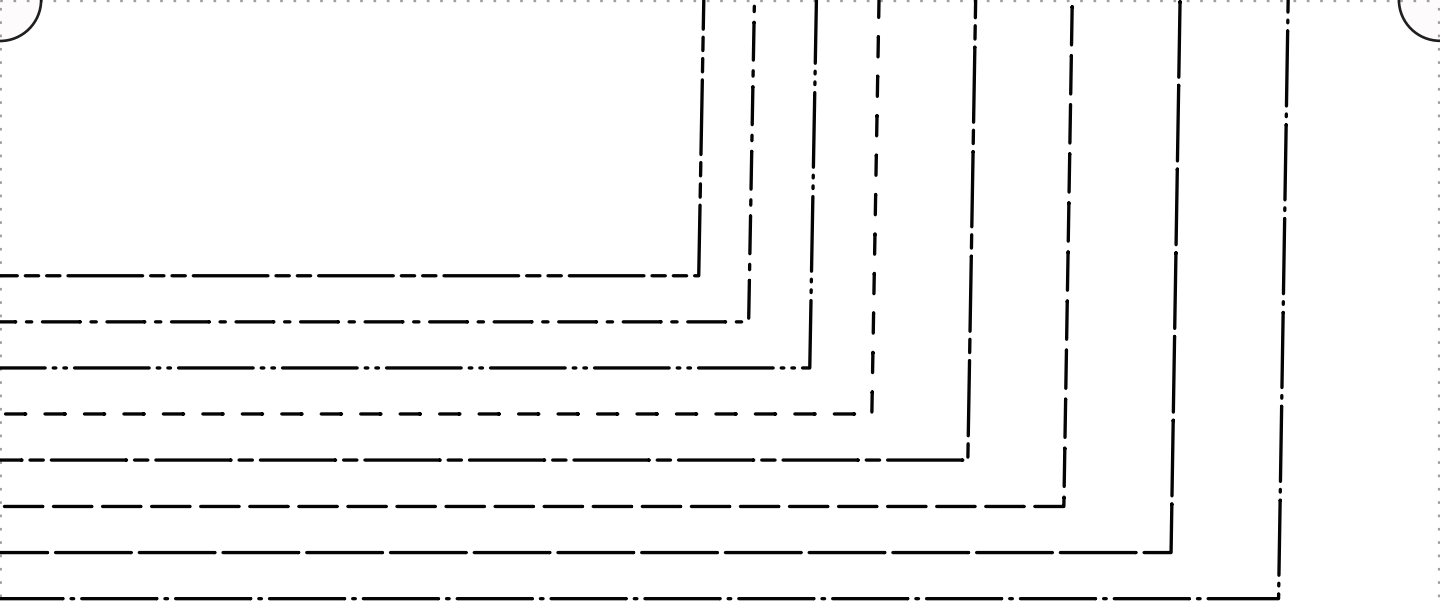

50

---

# *Thank you*

---

*We work hard on making our patterns beautiful  
enough to meet your standards.*

*If you feel like sharing praise or helpful criticism,  
please send us your comments to [ask@fabrics-store.com](mailto:ask@fabrics-store.com)*