

F|S

FABRICS-STORE.COM

Our linen is nothing short of addicting

VAL DRESS



STUNNING ELEGANCE

Effortlessly chic, the Val dress will look beautiful in any linen fabric. Use these style lines to add some color-blocking and create a unique dress that's guaranteed to turn heads!

Available in Ladies Sizes 0/2 to 28/30

866.620.2008 ASK@FABRICS-STORE.COM FABRICS-STORE.COM

MASHA WEARS IL042 909 FS PREMIER FINISH - 100% LINEN - (5.1 OZ/YD²)



Our lovely model Masha is wearing Size 4/6.

VAL PATTERN

The Val pattern is a stunning scoop-shaped open-back maxi dress with two adjustable ties and flattering princess seams. By following the curves of your body, these seams elongate your silhouette and create a figure slimming effect. We've added two front slits for a touch of sexy and ease of movement.

Sized for ladies 0/2 to 28/30

*Simple step-by-step instructions on our blog
The Thread at Fabrics-Store.com*

PATTERN DETAILS

#FABRICSSTOREVALPATTERN

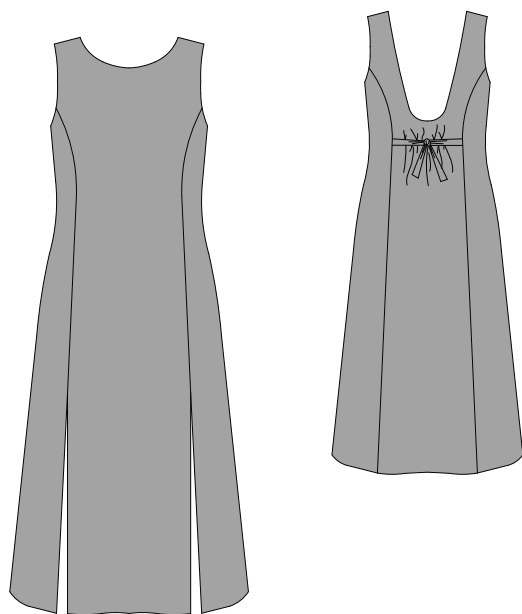

VAL PATTERN

Ladies Duo Sizes: 0/2 to 28/30

- Semi-fitted.
- Front leg slits.
- Plunging back neckline.
- Back waist tie.
- Maxi-length.

SEWING INSTRUCTIONS

This pattern is featured on our blog “The Thread” at Fabrics-Store.com. There you will find step-by-step photo instructions and can ask questions, post comments, or share your progress. Simply visit: blog.fabrics-store.com and enter “Val Pattern” in the search box.

SIZING & YARDAGE

Ladies Size Guide Based on Body Measurements in Inches

Size	0/2 (XS)	4/6 (S)	8/10 (M)	12/14 (L)	16/18 (XL)	20/22 (2X)	24/26 (3X)	28/30 (4X)
Bust	33-34	35-36	37-38	39-40	42-44	46-48	50-52	54-56
Waist	25-26	27-28	29-30	31-32	34-36	38-40	42-44	46-48
Hip	35-36	37-38	39-40	41-42	44-46	48-50	52-54	56-58

Finished Garment Measurements - Approximate in Inches

Size	0/2 (XS)	4/6 (S)	8/10 (M)	12/14 (L)	16/18 (XL)	20/22 (2X)	24/26 (3X)	28/30 (4X)
Bust	36.5	38.5	41	43.5	47.5	51.5	56	60.5
Waist	33.75	35.75	38.25	40.75	44.75	48.75	53.25	57.75
Hips	42.5	44.5	47	49.5	53.5	57.5	62	66.5

Estimated Yardage* - 54" Width Linen

Size	0/2	4/6	8/10	12/14	16/18	20/22	24/26	28/30
Yardage	3 Yards				3.5 Yards			

*Allow up to 10% extra fabric for shrinkage.

ALL SEAM ALLOWANCES ARE INCLUDED AND NOTED ON THE PATTERN AND IN THE TUTORIAL.

“Val” Sewing Pattern

For instructions visit: blog.fabrics-store.com and enter “Val Pattern” in the search box.

**2 Inch
Square to
Check Print
Accuracy**

PRINT ONLY THIS PAGE FIRST TO CHECK SCALE

IMPORTANT! PRINT AT ACTUAL SIZE, 100%, OR NO SCALING.

Formatted for paper sizes A4 and Letter.

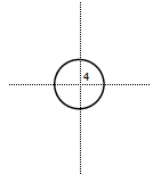

Simply overlap the page margins and align the markings in each corner to complete the circle and tape in place.

Layered PDF:
This pattern has embedded layers so you can print all sizes or a single size. See your .pdf viewers 'Layers' menu.

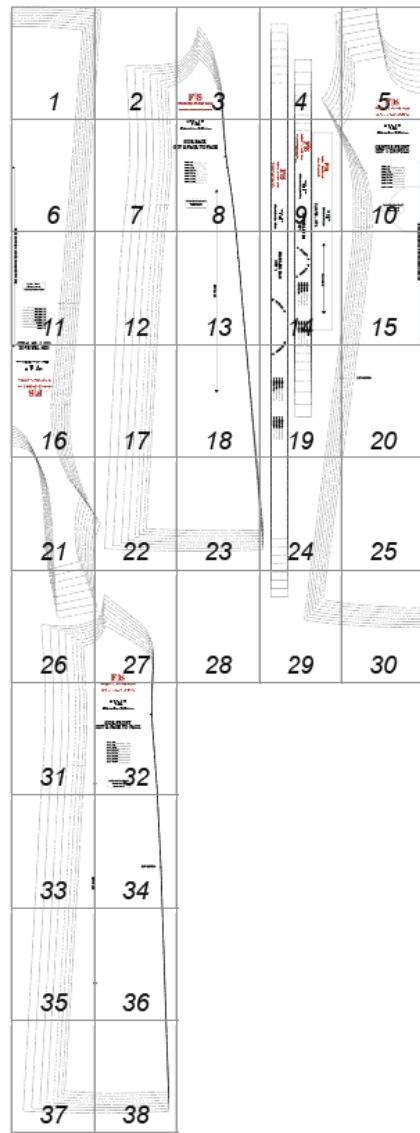

For instructions visit: blog.fabrics-store.com and enter “Val Pattern” in the search box.

1

2

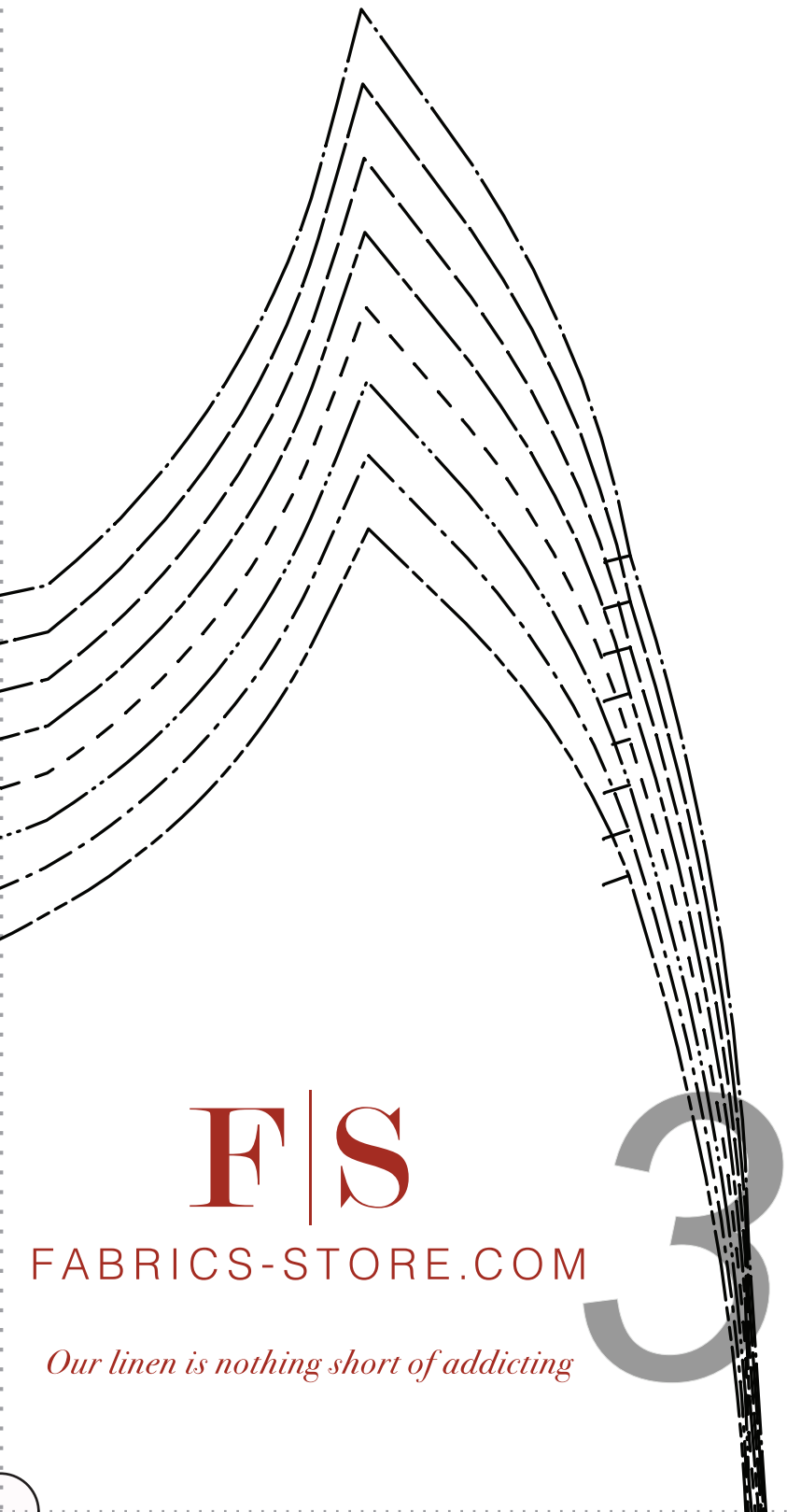

F|S

FABRICS-STORE.COM

Our linen is nothing short of addicting

3

4



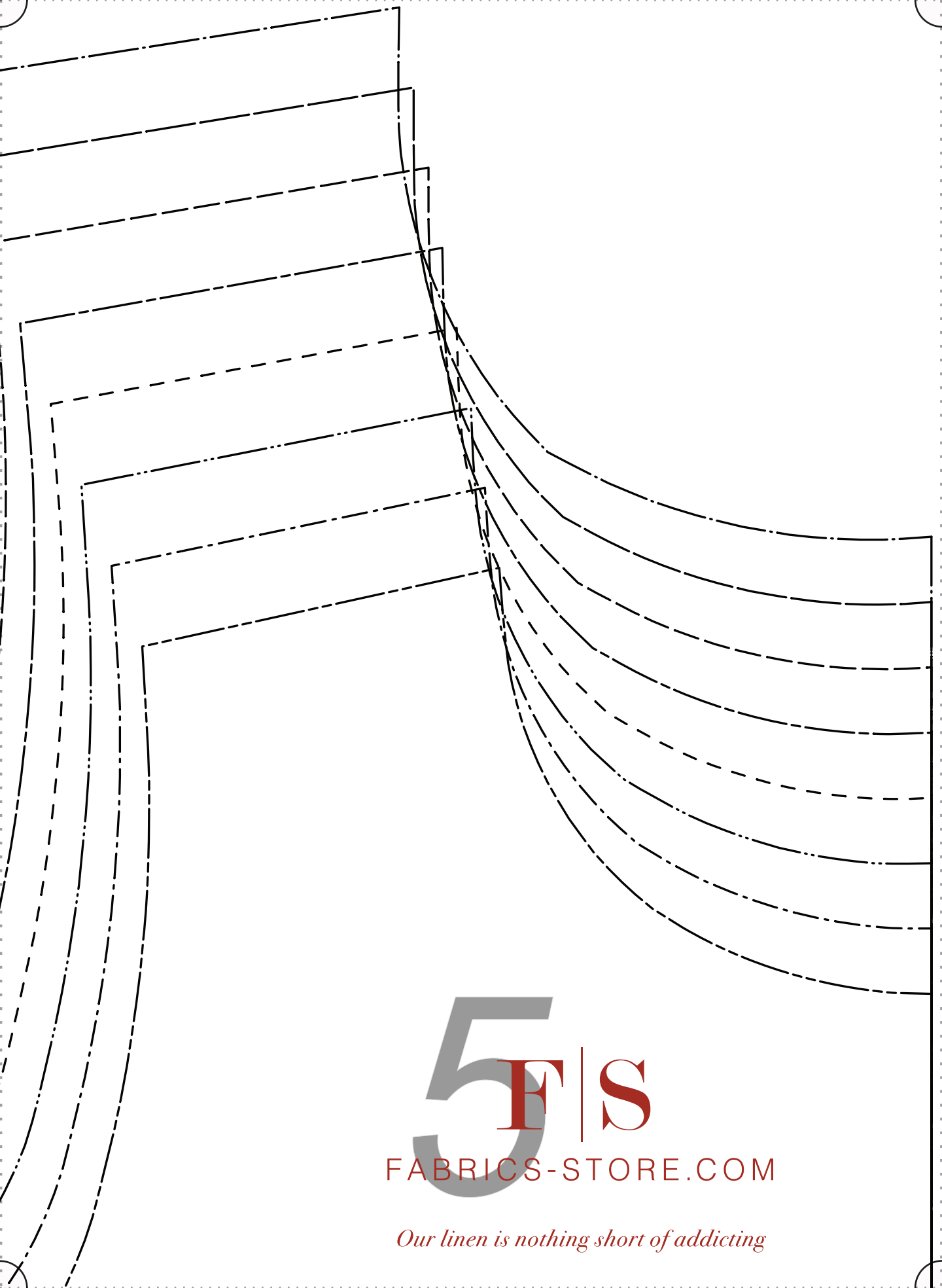

5 F | S

FABRICS-STORE.COM

Our linen is nothing short of addicting

6

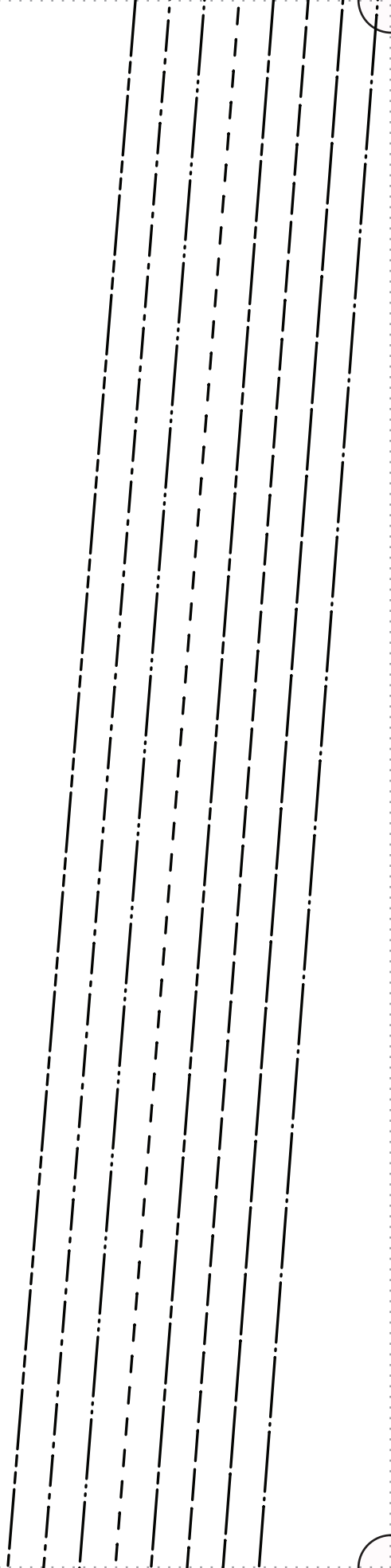

7

“Val”

#FabricStoreValPattern

SIDE BACK CUT 2 FACE TO FACE

SIZE 0/2

SIZE 4/6

SIZE 8/10

SIZE 12/14

SIZE 16/18

SIZE 20/22

SIZE 24/26

SIZE 28/30

All Seam Allowances Included

Main seams: 3/8"

Bottom Hem: 1"

8

F|S

FABRICS-STORE.COM

Our linen is nothing short of addicting

“Val”

#FabricStoreValPattern

BACK TIE – CUT 4

F|S

FABRICS-STORE.COM

Our linen is nothing short of addicting

“Val”

#FabricStoreValPattern

ARMHOLE
CUT 2

F|S

FABRICS-STORE.COM

Our linen is nothing short of addicting

“Val”

#FabricStoreValPattern

“Val”

#FabricStoreValPattern

CENTER FRONT CUT 1 ON FOLD

SIZE 0/2 _____

SIZE 4/6 _____

SIZE 8/10 _____

SIZE 12/14 _____

SIZE 16/18 _____

SIZE 20/22 _____

SIZE 24/26 _____

SIZE 28/30 _____

All Seam Allowances Included

Main seams: 3/8"

Bottom Hem: 1"

10

CUT 1 ON FOLD

CUT 1 ON FOLD

- SIZE 0/2
- SIZE 4/6
- SIZE 8/10
- SIZE 12/14
- SIZE 16/18
- SIZE 20/22
- SIZE 24/26
- SIZE 28/30

All Seam Allowances Included
Main seams: 3/8"
Bottom Hem: 1"

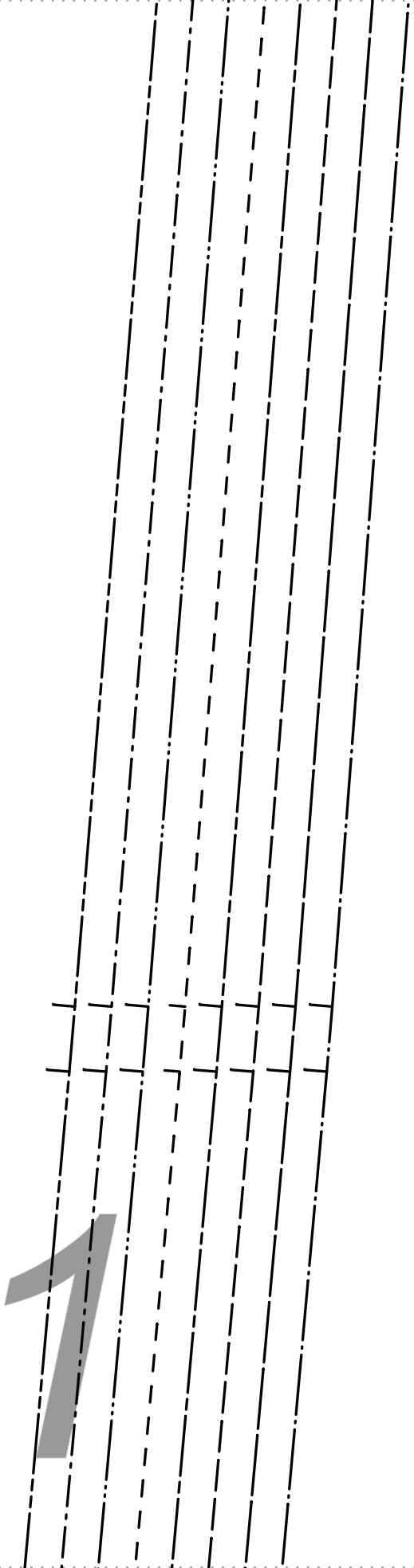

12

13

GRAINLINE

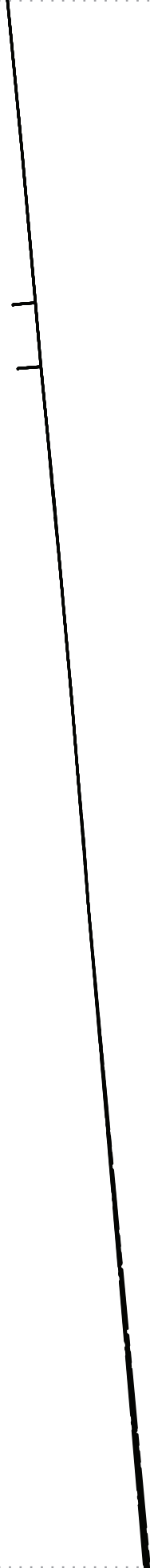

GRAINLINE

BIAS

GRAINLINE

GRAINLINE

SIZE_0/2
SIZE_4/6
SIZE_8/10
SIZE_12/14

SIZE_16/18
SIZE_20/22
SIZE_24/26
SIZE_28/30

NECKLINE BIAS
CUT 1

GRAINLINE

15

PLACE ON FOLD ALONG GRAINLINE OF PAPER

CENTER BACK

#FabricsStoreValPattern

“Val”

Our linen is nothing short of addicting

FABRICS-STORE.COM

F|S

16

17



18

GRAINLINE

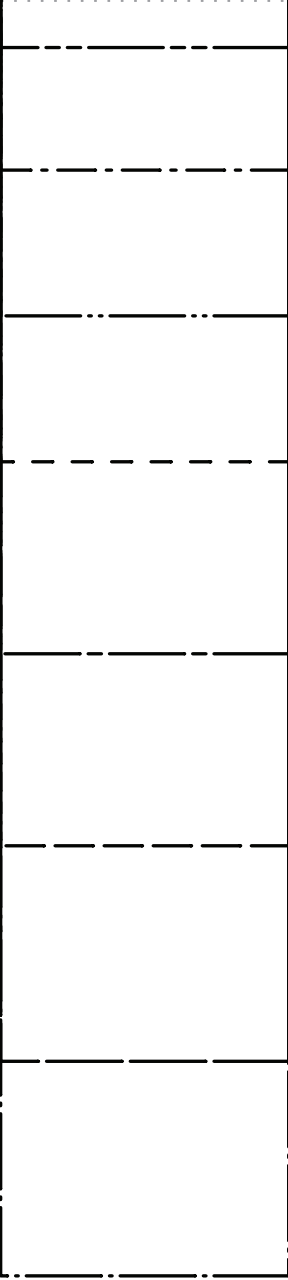

SIZE 0/2 _____
SIZE 4/6 _____
SIZE 8/10 _____
SIZE 12/14 _____

SIZE 16/18 _____
SIZE 20/22 _____
SIZE 24/26 _____
SIZE 28/30 _____

19

A technical drawing of a tapered shaft, shown in a perspective view. The shaft is wider at the top and tapers towards the bottom. The top edge is notched, with the notch being a semi-circular cutout. The drawing uses solid lines for the visible edges and dashed lines for the hidden edges. A label 'SLIT NOTCH' with a leader line points to the notched edge.

SLIT NOTCH

20

The image features a decorative background consisting of a grid of dashed lines. The grid is composed of vertical and horizontal lines that intersect to form a pattern of squares. In the lower-left quadrant, the numbers '21' are prominently displayed in a large, bold, grey font. The '2' is positioned to the left of the '1'. The background also includes several curved, dashed lines that sweep across the right side of the page, creating a sense of movement and depth. The overall design is clean and modern, with a focus on geometric patterns and typography.

21

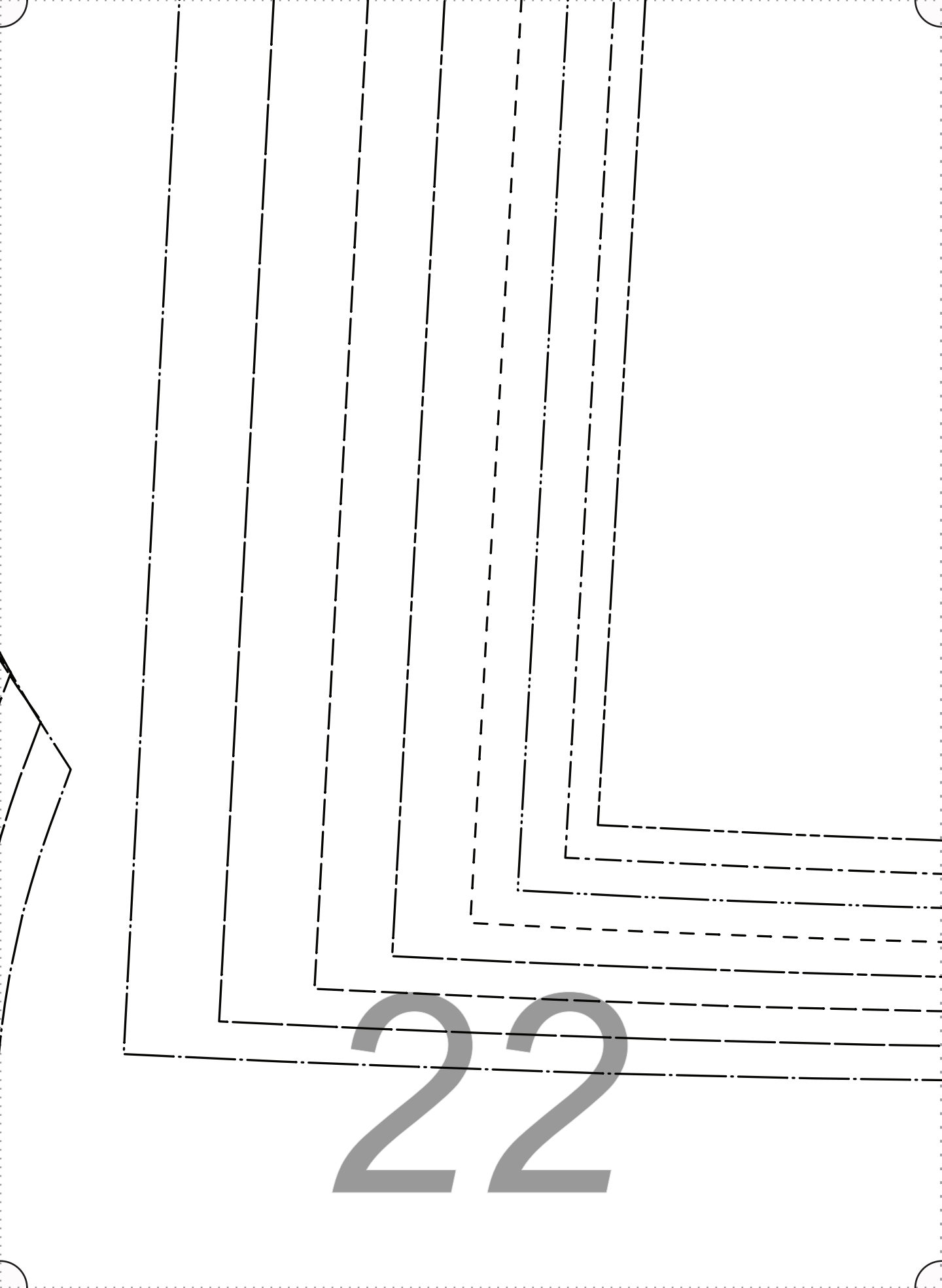

23

24

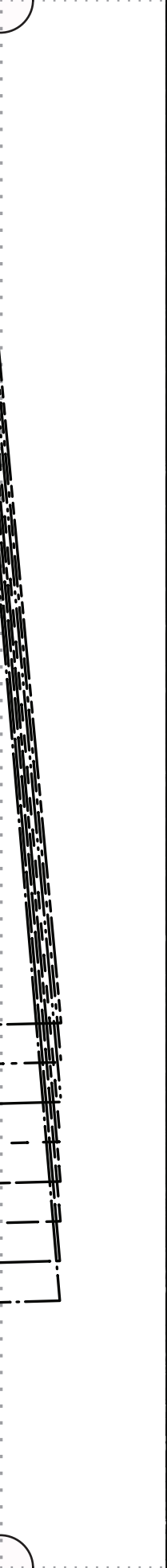
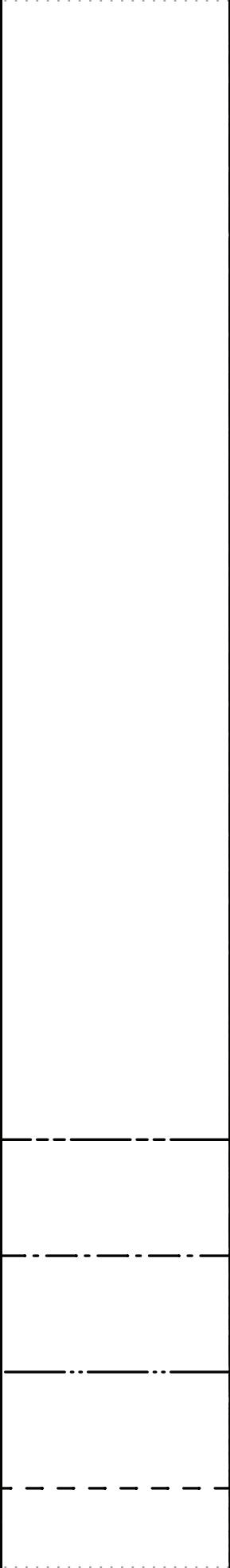
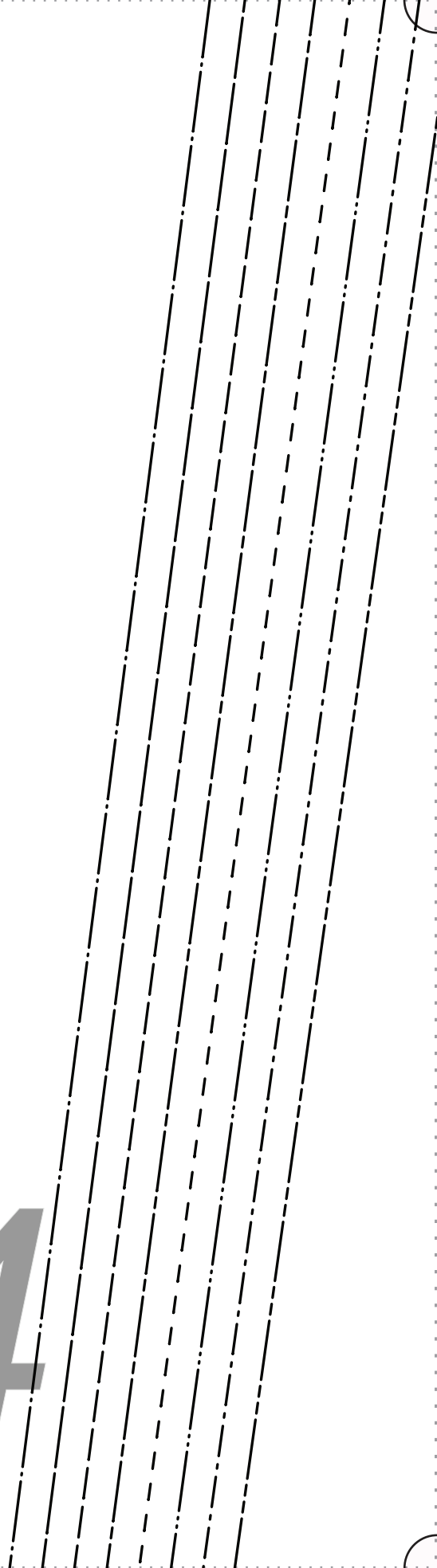

25

26

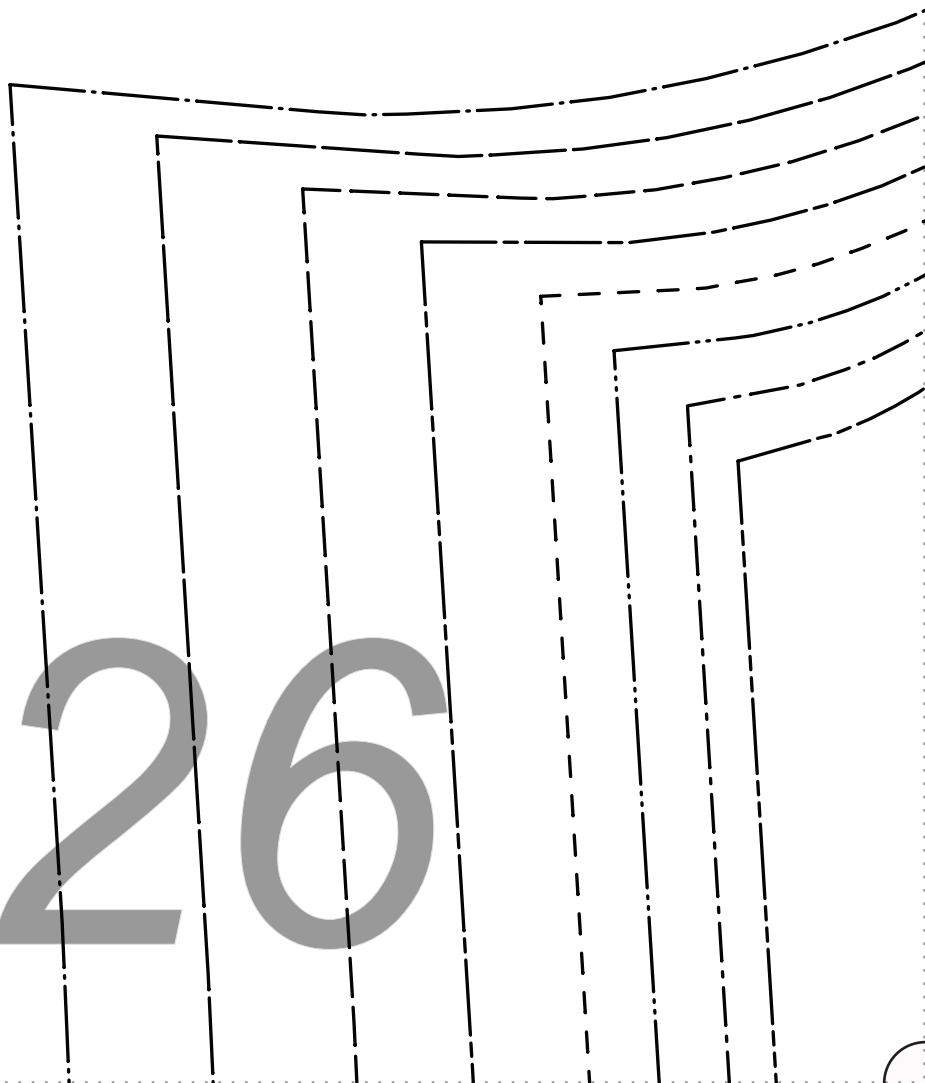
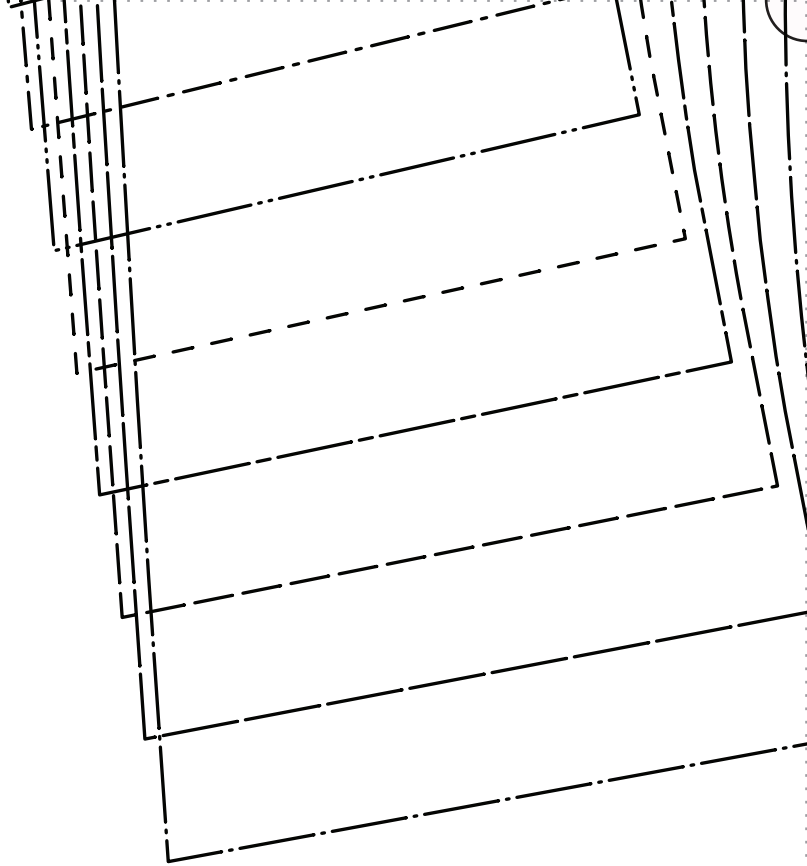

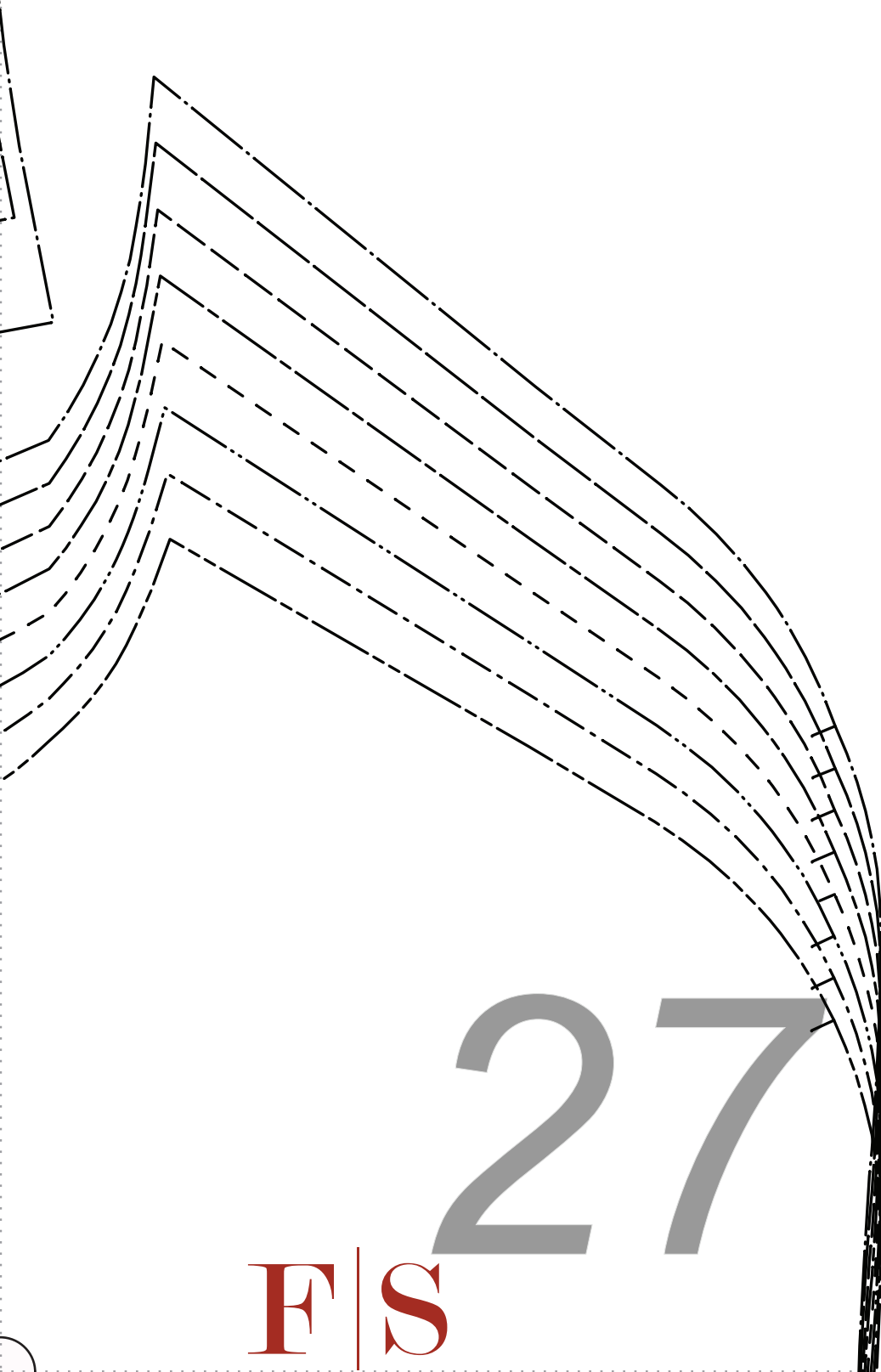

27

F|S

28

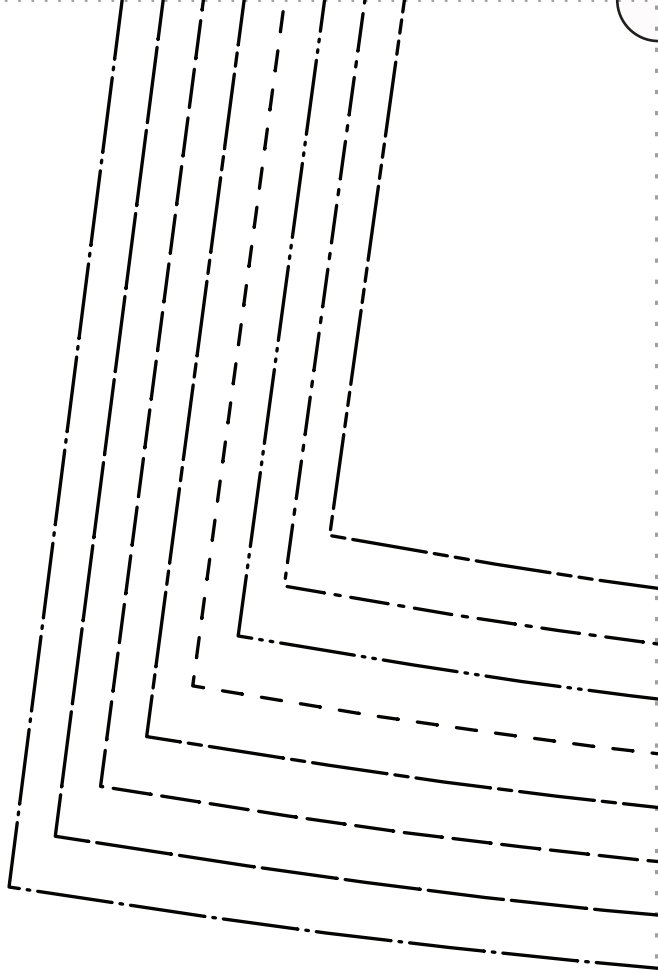
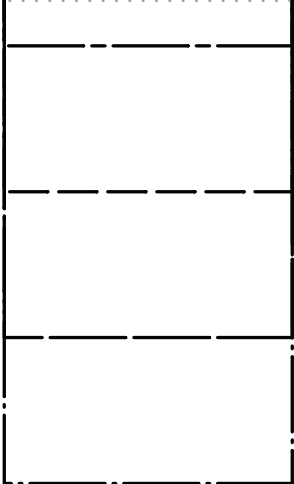

29

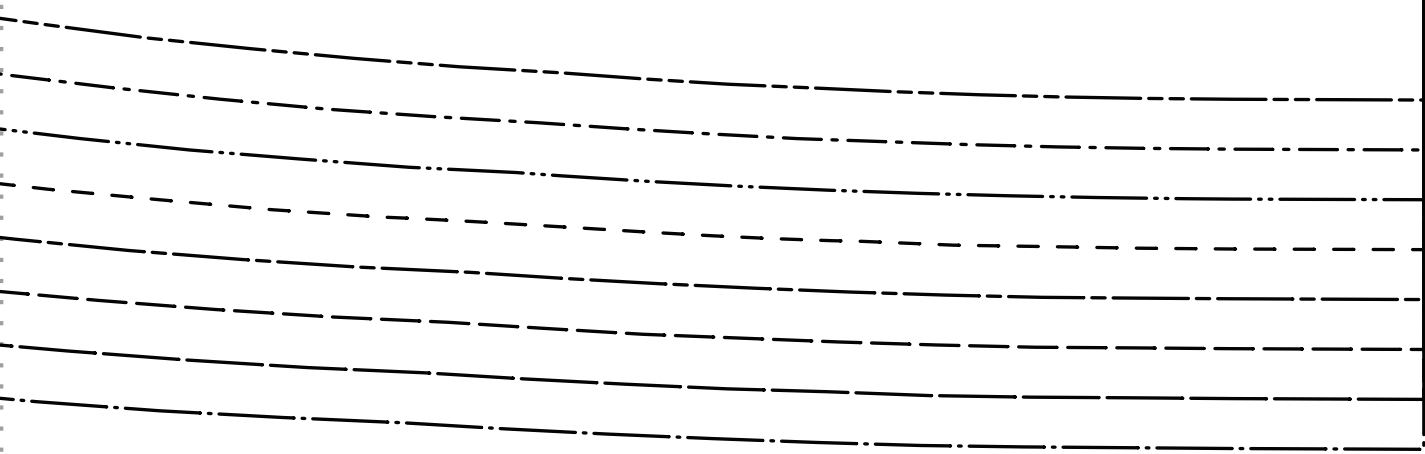

30

3 1

Our linen is nothing short of addicting

“Val”

#FabricStoreValPattern

SIDE FRONT
CUT 2 FACE TO FACE

SIZE 0/2 _____

SIZE 4/6 _____

SIZE 8/10 _____

SIZE 12/14 _____

SIZE 16/18 _____

SIZE 20/22 _____

SIZE 24/26 _____

SIZE 28/30 _____

All Seam Allowances Included

Main seams: 3/8"

Bottom Hem: 1"

32

33

SLIT NOTCH

34

35

36

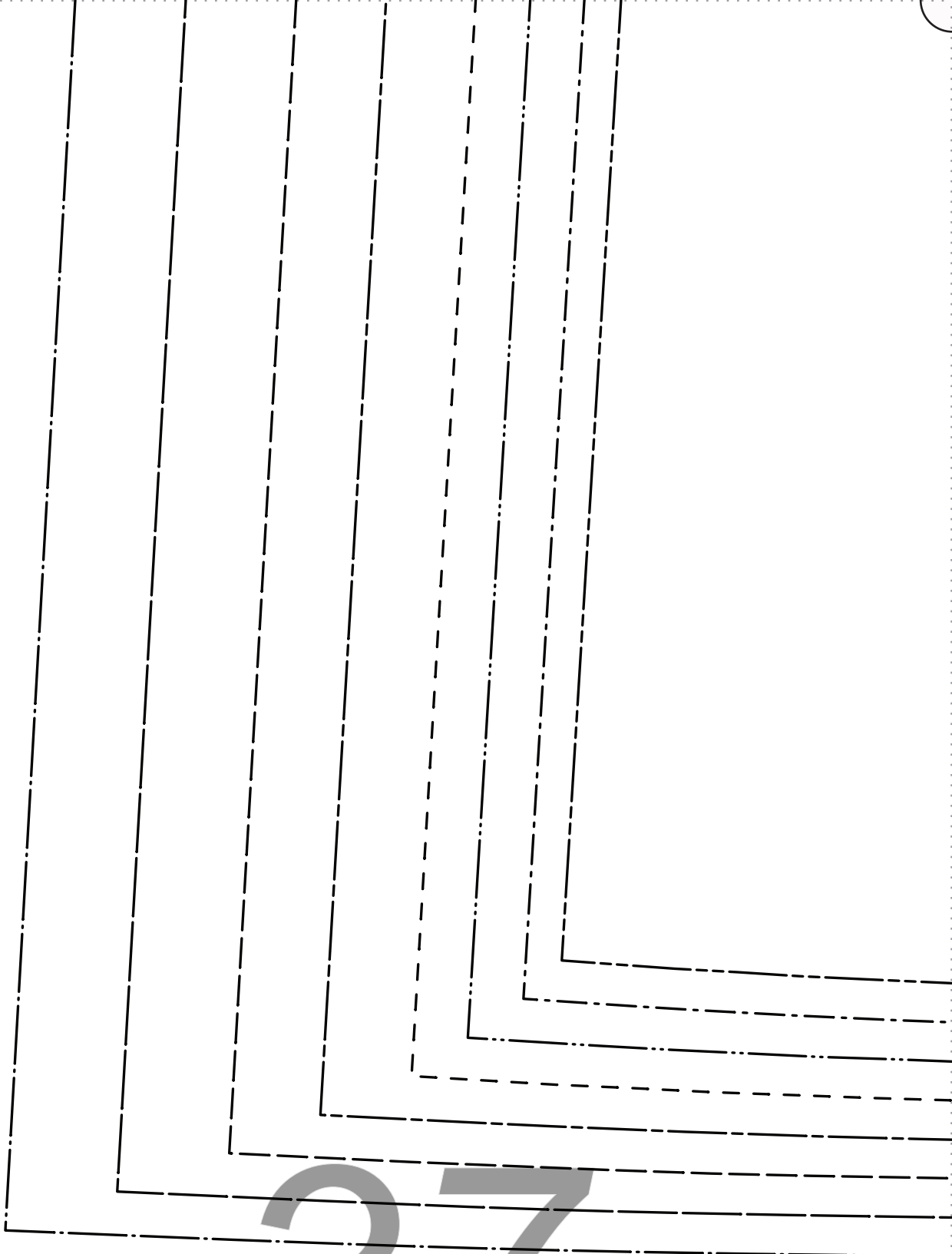

37

38

Thank you

*We work hard on making our patterns beautiful
enough to meet your standards.*

*If you feel like sharing praise or helpful criticism, please
send us your comments to ask@fabrics-store.com*